



RICAMBI PER CALDAIE, SCALDABAGNI E RADIATORI A GAS



Ricambi specifici per caldaie a gas	Pag. 2
Apparecchiature e schede elettroniche	Pag. 26
Resistenze per scaldabagni	Pag. 32
Anodi al magnesio	Pag. 32
Sonde di temperatura	Pag. 33
Elettrovalvole e valvole gas	Pag. 35
Bruciatori pilota	Pag. 40
Accenditori e termocoppie	Pag. 41
Candelette accensione e rilevazione	Pag. 43
Mantelli copricaldaia	Pag. 43
Estrattori fumi	Pag. 44
Tappi e prelievi fumi	Pag. 45
Vetrini per caldaia	Pag. 45
Pressostati fumi per caldaia	Pag. 46
Pompe scarico condensa	Pag. 47
Neutralizzatori acidità residua	Pag. 48
Tubi e Accessori per fumistica	Pag. 50
Tubi raccordo camino in acciaio inox	Pag. 53
Valvole flussostatiche	Pag. 55
Flussostati e pressostati acqua	Pag. 56
Circolatori per caldaie	Pag. 58
Valvole deviatrici	Pag. 60
Cartucce e motori per valvole 3 vie caldaia	Pag. 62
Vasi d'espansione	Pag. 63
Minicompressore gonfiavasi	Pag. 65
Valvole di sicurezza	Pag. 66
Valvole di sfiato aria	Pag. 67
Rubinetti di carico e scarico	Pag. 68
Scambiatori a piastre	Pag. 70
Termometri	Pag. 72
Manometri e termoidrometri	Pag. 73
Termostati a capillare	Pag. 74
Termostati a microcontatto e pirostati	Pag. 75
Membrane per caldaie e scaldabagni	Pag. 76
Prodotti pulizia caldaie	Pag. 77
Guarnizioni, sigillanti e lubrificanti	Pag. 79



RICAMBI SPECIFICI PER CALDAIE MURALI A GAS

RIELLO/BERETTA	Pag. 3
IMMERGAS	Pag. 6
HSD - HERMANN/SAUNIER DUVAL	Pag. 9
RHOSS	Pag. 11
OCEAN/BAXI	Pag. 12
ARISTON/MTS/RADI/SIMAT	Pag. 14
UNICAL	Pag. 16
VAILLANT	Pag. 18
CHAFFOTEAUX et MAURY	Pag. 20
FONDITAL/NOVA FLORIDA	Pag. 21
FERROLI/FER	Pag. 22
SILE	Pag. 24

Su richiesta sono disponibili tutti
i ricambi originali per:



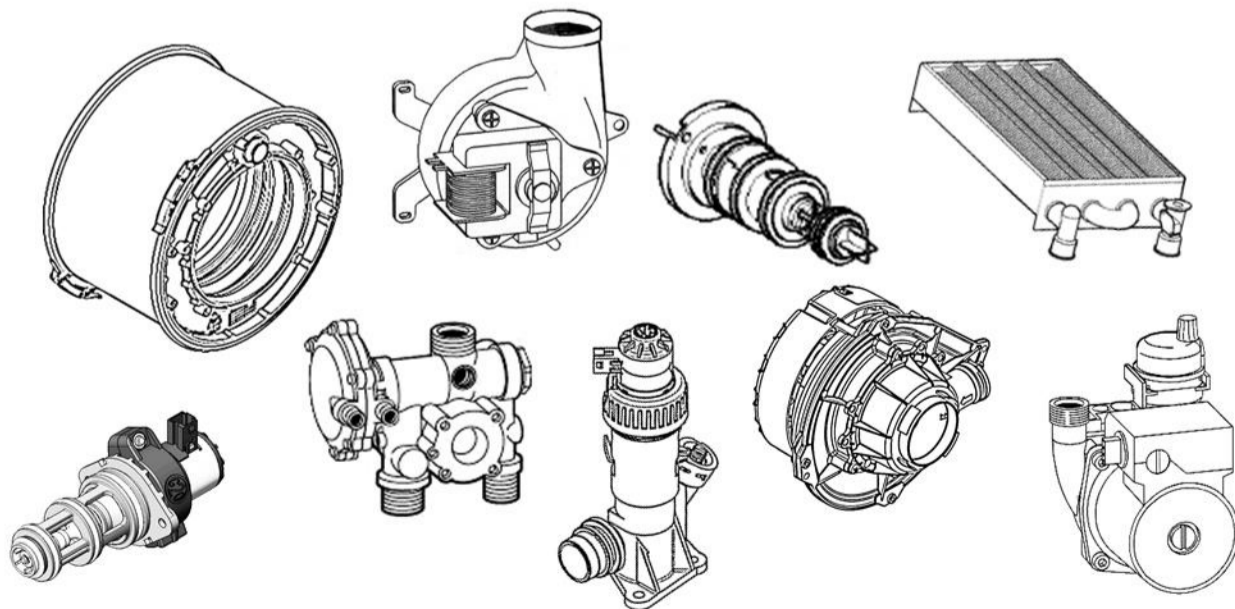

**IMMERGAS - ARISTON/MTS - FONDITAL/NOVA
FLORIDA - BERETTA - HERMANN - UNICAL
CHAFFOTEAUX et MAURY - OCEAN/BAXI**



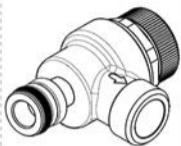
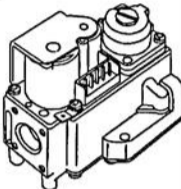
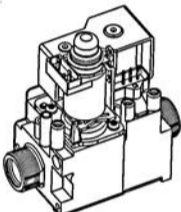
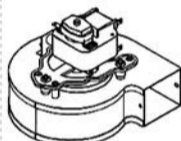

RIELLO/BERETTA**Su richiesta disponibili tutti i ricambi originali**

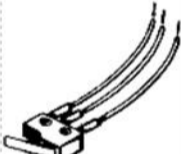
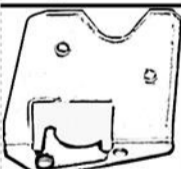
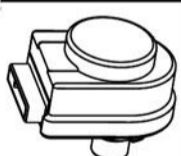
			EURO
	TP022	Flussostato magnetico Bitron attacchi 1/2" M	24,00
	CR005	Rubinetto di caricamento Beretta Idra, Idra Exclusive, Riello2000	16,00
	CR015	Premistoppa Beretta Exclusive, Meteo	5,00
	CO011	Premistoppa	5,00
	CR018	Raccordo distanziatore Riello Benefit, Residence	9,00
	CR020	Cartuccia 3vie Beretta Mynute, Exclusive Riello Residence, Family	46,00
	GR710	Membrana caldaia/scaldabagno N°3, 55, 67, 71, 75, 76, 75A Vedi Pag.75	5,00
	TI006	Termoidrometro bianco 1/4" M Quad. Ø46mm Foro Ø42mm Riello Domus	21,00
	CR012	Scambiatore 14 piastre attacchi a O.R.	65,00
	CR019	Scambiatore 16 piastre attacchi a O.R.	64,00
	VE110	Vaso espansione lt.10 - 1/4" C Ø387mm x 120 Beretta Idra, Riello2000	69,00
	VE118	Vaso espansione lt. 8 - 1/2" M Ø392mm x 75 + staffa Beretta Superexclusive, Riello Nuova Benessere	69,00
	VE114	Vaso espansione lt. 8 Ø416mm x 75 1/4" M + staffa Beretta Idra Exclusive, Riello Benefit	84,00

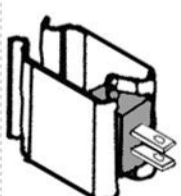
Segue RIELLO/BERETTA

			EURO
	CR008	Valvola sicurezza 3 bar Attacco O.R.	11,00
	CR011	Valvola sicurezza 3 bar Materiale composito Attacco O.R.	10,00
	GR012	Valvola gas Honeywell VK4105/A-1027 (Ex 1050)	223,00
	GR013	Valvola gas Honeywell VK4105/C-1009 (Ex 1025)	210,00
	GR150	Valvola gas Sit SIGMA 845.070 Attacchi 3/4" M	120,00
	GR172	Valvola gas Sit SIGMA 848.160 - Attacchi 3/4" M Modelli a condensazione	235,00
	CE007	Estrattore fumi 250/2C-RA Imbocco quadro 52x60mm Ventola Ø97 - 24KW	70,00
	GP016	Pressostato fumi Huba Control 0,65/0,51 mbar	30,00
	CI005	Microinterruttore 3 fili Universale	9,00
	CR009	Staffa microinterruttore	5,00
	TZ131	Motore/Attuatore ELBI	27,00
	TZ133	Motore/Attuatore ELBI	48,00
	CR017	Sonda temperatura a contatto Honeywell T7335	18,00

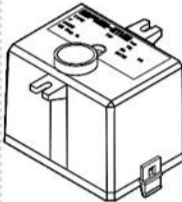
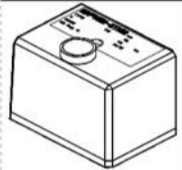
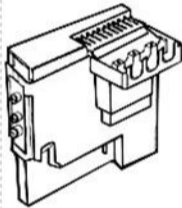
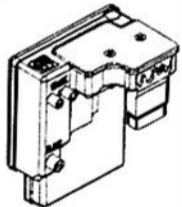

Segue RIELLO/BERETTA

			EURO
	CR010	Sonda temperatura Blu	6,00
	CI001	Sonda temperatura Nera	6,00
	CR016	Sonda temperatura Blu O.R.	12,00
	RA112	Apparecchiatura Brahma SM191.1 Beretta Idra Ionizzate, Riello2000	154,00
	RA117	Apparecchiatura Brahma CM391.2 Basamento stagna	161,00
	RA807	Scheda Honeywell S4565CF/1045 (ex 1052) Riello a basamento	293,00
	RA808	Scheda Honeywell S4565AF/1007 (ex 1064) Riello a basamento IN ESAURIMENTO	234,00
	RA600	Scheda SIT 537-002 ABC (ex 507-002) Beretta Superexclusive, Riello Benessere	291,00



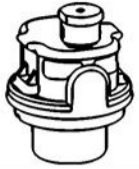

IMMERGAS**Su richiesta disponibili tutti i ricambi originali**

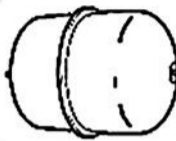
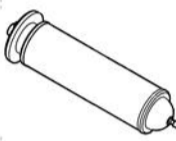
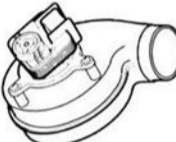
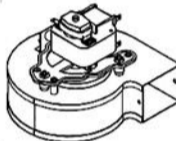
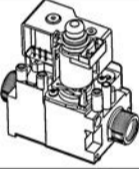
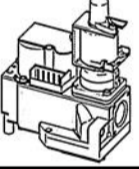
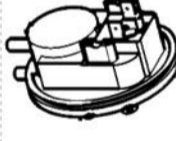
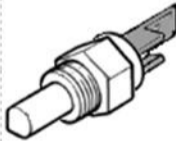
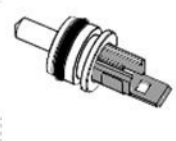
			EURO
	CI006	Rubinetto di caricamento L=104mm - Extra	11,00
	CI013	Rubinetto di caricamento Eolo, Zeus, Supernike, Nike, Supereolo	17,00
	RS104	Anodo al magnesio Ø16 x L=600mm Filetto 4ma	15,00
	CI008	Termoidrometro Bianco Foro Ø40mm Attacco 1/4" M	21,00
	TP022	Flussostato magnetico Bitron attacchi 1/2" M	24,00
 72	GR710	Membrana - N°70, 72, 82 Vedi Pag.75	5,00
	CI002	Valvola 3 vie Giannoni Mini	178,00
	CI010	Kit membrana Giannoni Mini ed Extra	14,00
	CI007	Scambiatore 13 piastre Nike, Eolo Mini	84,00
	CI015	Scambiatore 14 piastre Eolo Mini kw, Nike Mini kw Eolo Extra kw	50,00
	VE530	Testina di ricambio valvola sicurezza 3 bar	8,00
	VE531	Testina di ricambio valvola sicurezza 8 bar	9,00
	VE524	Valvola sicurezza 3 bar Attacco O.R.	10,00



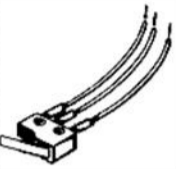

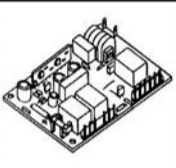
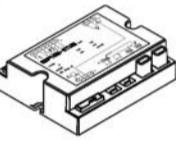
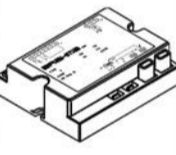
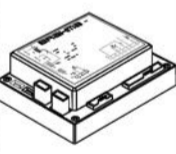
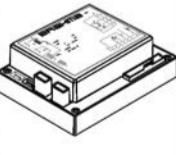
Segue IMMERGAS

			EURO
	VE480	Valvola sfiato Caleffi plastica ad Innesto rapido per pompe Wilo e Grundfos	10,00
	VE116	Vaso espansione It.8 - 3/8\"M 515mm x 200mm x 110mm	67,00
	VE006	Vaso idrico It.2 - 1/2\"M Ø120 x 235mm Hercules, Zeus	41,00
	VE012	Vaso idrico Style It.4 - 1/2\"M Ø80 x 655mm Per bollitori It.60/120	102,00
	CE004	Estrattore fumi 200/2C-RA Imbocco Ø58mm Ventola Ø108 - Vari modelli	124,00
	CE006	Estrattore fumi 250/2C-RA Imbocco 60x60mm Supereolo, Nuova Zeus	120,00
	GR151	Valvola gas SIT Sigma 845.063 (Ex 109) - 3/4\"M Vari modelli	120,00
	GR023	Valvola gas Honeywell VK4105/M-2055 Nuova Avio, Zeus Iono, Vip	370,00
	GP010	Pressostato fumi Huba Control Reg.fissa 0,47/0,35mbar	30,00
	CI001	Sonda temperatura Nera	6,00
	CI003	Sonda temperatura rossa Corpo ottone (ex grigia)	6,00
	CM005	Sonda temperatura Rossa	6,00
	CO010	Sonda temperatura Bianca	6,00
	CI009	Sonda temperatura Rossa Innesto a O.R. Modelli KW	12,00



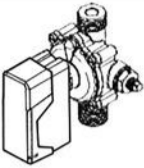
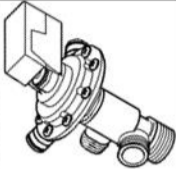
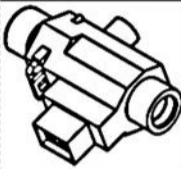

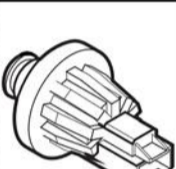
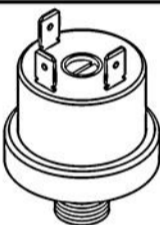
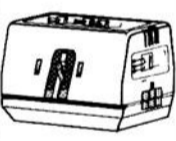
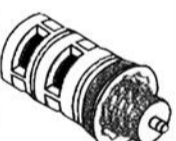
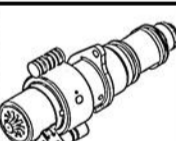
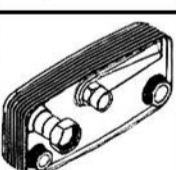
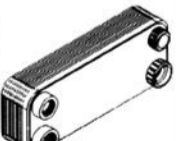
Segue IMMERGAS

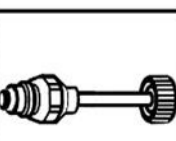
			EURO
	CI004	Microinterruttore con guscio Supernike, Supereolo, Eolo, Nike	11,00
	CI005	Microinterruttore a leva 3 fili Universale	9,00
	CI014	Microinterruttore a forchetta Modelli Mini	20,00
	RA651	Scheda accensione Bertelli & P. FM31 (Sostituisce anche FM19)	160,00
	RA140	Apparecchiatura Brahma CM32	143,00
	RA138	Apparecchiatura Brahma SM11	138,00
	RA146	Apparecchiatura Brahma CM31	137,00
	RA139	Apparecchiatura Brahma CM11	127,00
	RA144	Apparecchiatura Brahma CM31/F	138,00
	RA137	Apparecchiatura Brahma CM11/F	136,00
	RA159	Apparecchiatura Brahma CM11/O	140,00
	RA160	Apparecchiatura Brahma CM11F/O Victrix	144,00
	TZ131	Motore/attuatore ELBI	27,00
	TZ133	Motore/Attuatore ELBI Modelli vari	48,00

HSD - HERMANN/SAUNIER DUVAL**Su richiesta disponibili tutti i ricambi originali**

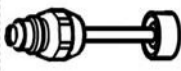
			EURO
	TP005	Flussostato Giannoni SF11 a membrana 1/2" M Modelli Laser	75,00
	CH007	Valvola 3 vie Giannoni Micra, Supermicra, Spaziotekno	212,00
	TP022	Flussostato magnetico Bitron Attacchi 1/2" M	24,00
	CV019	Flussostato rotativo Isofast E-P, Themafast, Isomax, Opalia	33,00
	CV018	Trasduttore di pressione Spazio4, Micra4, Combitek Themafast condens Semiatek condens	21,00
	TP051	Pressostato di sicurezza mancanza acqua 1/4" M Per modelli senza carico Automatico (Serie Spazio)	18,00
	TZ107	Servocomando Honeywell VC6612 - 230V per 3 vie Micro e morsettiera Molex	109,00
	TZ104	Otturatore di ricambio per valvola VC6012/6612	53,00
	CV020	Cartuccia 3 vie motorizzata Adattabile Thera3, Thesi3, Micra3	59,00
	CH011	Scambiatore 14 piastre Attacchi filettati Micra, Micrapiù, Spaziotekno	83,00
	CF005	Attacchi filettati 14 piastre 1/2 - 3/4" M Adattabile Spazio plus	60,00
	VE521	Rubinetto di caricamento L=37mm	10,00
	VE529	Rubinetto di carico 75 mm	11,00

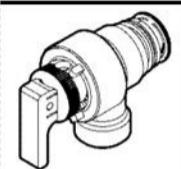
Segue HSD - HERMANN/SAUNIER DUVAL

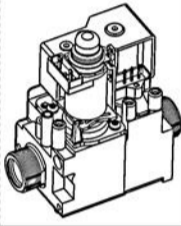
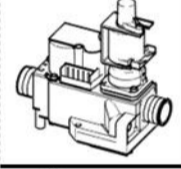
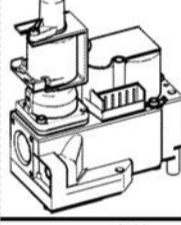
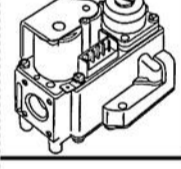
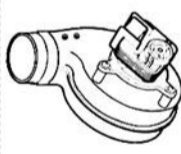
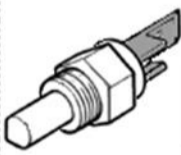
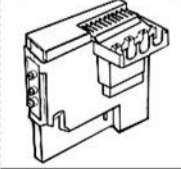
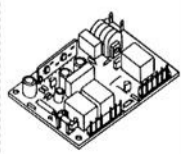
			EURO
	CI006	Rubinetto di caricamento L=104mm	11,00
	TI006	Termoidrometro bianco 1/4"M Quadrante Ø46mm Foro Ø42mm	21,00
	CV022	Valvola sicurezza a innesto rapido VM,VMW	15,00
	CH003	Elettrovalvola caricamento CEME 1/4"M x 1/2"M Serie Spazio	40,00
	GR171	Valvola gas SIT SIGMA 848.107 Attacchi filettati 3/4"M Modelli a condensazione	186,00
	GR024	Valvola gas Honeywell VK4105/M-2105 con Modureg Filetti 3/4"M	335,00
	GR015	Valvola gas Honeywell VK4105/M-2048 con Modureg Attacchi filettati 1/2"F	323,00
	GR017	Valvola gas Honeywell VK4105/A-1035 Attacchi filettati 1/2"F	174,00
	CH001	Estrattore fumi EBM G2K097 Imbocco Ø56mm fori venturi RO Ventola Ø97 Adattabile Laser, Master, Micra, Spazio	100,00
	CR010	Sonda temperatura Blu	6,00
	CM005	Sonda temperatura Rossa	6,00
	CO010	Sonda temperatura Bianca	6,00
	RA809	Scheda Honeywell S4565CD/1039 (Ex 1021) Eura, Spazio 0/1	245,00
	RA226	Bertelli FT14 Scheda accensione Adattabile Laser 24-29 E	149,00

Segue HSD - HERMANN/SAUNIER DUVAL

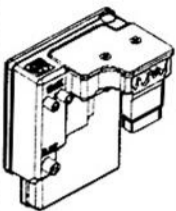
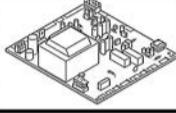
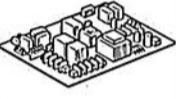
			EURO
	RA602	Scheda Sit 537-301 ABC (ex 507-301) Habitat, Spazio Tekno, Micra	272,00
	RA611	Scheda Sit 579-604 DBC (ex 577.604, ex 577.603) Modelli a condensazione	325,00
	RA222	SM07407 Scheda modulazione Micra2 (fino al 2009)	240,00
	RA223	SM07414 Scheda modulazione con display Thesi, Thesi condensing	303,00

RHOSS

			EURO
	TZ015	Mut SF20/E - 3/4" M Valvola 3 vie motorizzata Serie Spazio con bollitore	142,00
	TP010	Mut SFS1 - 1/4" M Flussostato differenziale Micro SPDT Spazio bollitore	87,00
 55	GR710	Membrana N° 55, 86 Vedi Pag.75	5,00
	CR012	Scambiatore sanitario 14P Attacchi OR Serie Spazio istantanea	65,00
	CM002	Scambiatore sanitario 14P Attacchi OR Serie Aurora istantanea	61,00
	CE034	Estrattore FIME GR800-RO Ventola RL97 con prelievi Imbocco Ø56mm - Spazio	75,00
	CE003	Estrattore LN200/2C-RO Imbocco Ø58mm Ventola Ø108	169,00
	RA651	Scheda accensione FM31 Bertelli & P. (Sost.FM37) Serie Aurora	160,00
	TZ131	Motore/attuatore ELBI 230V Serie Aurora con bollitore	27,00



OCEAN - BAXI**Su richiesta disponibili tutti i ricambi originali**

			EURO
	TP051	Pressostato di sicurezza mancanza acqua 1/4" M	18,00
	CO011	Premistoppa sanitario Luna, Eco	5,00
	CO013	Testina Jolly filettata Baxi Luna, Eco, Luna3	13,00
	VE524	Valvola sicurezza 3 bar Attacco O.R.	10,00
	CO015	Valvola sicurezza 3 bar Materiale composito Attacco O.R. Baxi Eco5-Evolution prime	27,00
	CO012	Rubinetto di caricamento Baxi Luna, Eco	25,00
	CO006	Rubinetto di caricamento Duo tec, Eco compact	9,00
	CM008	Cartuccia 3vie Baxi Duo tec, Eco compact	20,00
	CO014	Cartuccia 3vie Baxi Luna 3, Luna 3 Confort, Luna 3 HT	40,00
	CO007	Scambiatore sanitario 14 piastre Ocean Luna	60,00
	CO008	Scambiatore sanitario 16 piastre Baxi Luna, Eco	69,00
	CO009	Scambiatore sanitario 14 piastre Baxi Luna, Eco, Prime	60,00
	CM002	Scambiatore sanitario 14 piastre Attacchi O.R. LunaPlatinum+GA Duo tec+GA, Luna Duotec E	61,00
	CO004	Vaso espansione lt.8 Ø387 - Attacco 14MA Serie Baxi	66,00

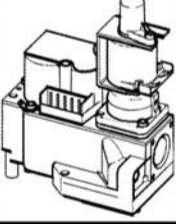
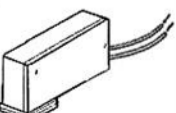
Segue OCEAN - BAXI



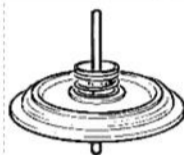
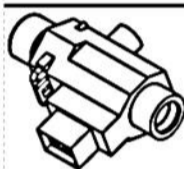

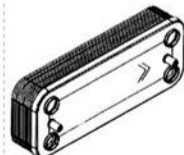

			EURO
 69	GR710	Membrana N° 55, 69, 83 Vedi Pag.75	5,00
	CE011	Estrattore fumi RLG108-RA Imbocco Ø56 - Ventola Ø108 Baxi Luna 240, Eco 240	108,00
	CE006	Estrattore fumi 250/2C-RA Imbocco 60x60mm Ventola Ø97 Ocean Luna FI - Nuvola	120,00
	CE005	Estrattore fumi EBM-RL108 Imbocco 60x60mm Ventola Ø108 2 velocità Ocean Luna FP	186,00
	GR151	Valvola gas SIT Sigma 845.063 (Ex 109) Filettata 3/4" M	120,00
	GR152	Valvola gas SIT Sigma 845.131 (Ex 048) Flangiata Luna, Nuvola, Galaxi	228,00
	GR170	Valvola gas SIT Sigma 848.054 Flangiata Baxi Luna HT	210,00
	GR022	Valvola gas Honeywell VK4105/M-5108 Flangiata Baxi Luna, Eco	176,00
	CI001	Sonda temperatura Nera	6,00
	CR010	Sonda temperatura Blu	6,00
	CO010	Sonda temperatura Bianca	6,00
	CO020	Microinterruttore con staffa Luna, Eco	15,00
	CO021	Microinterruttore cablato Luna, Nuvola, Copper	27,00

ARISTON/SIMAT/RADI/MTS**Su richiesta disponibili tutti i ricambi originali**

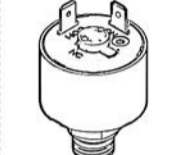

			EURO
	TP204	Valvola 3 vie Giannoni Dx Meta, Dia, RX, SP	178,00
	CM008	Cartuccia 3vie Genus Premium, Clas, Egis	20,00
	TP004	Membrana per 3vie Meta, Dia, RX, SP	14,00
	TP022	Flussostato magnetico Bitron Attacchi 1/2" M One, Microtec, Next, Est	24,00
	CR005	Rubinetto di caricamento Meta, Dia, Genus	16,00
	CO006	Rubinetto di caricamento Egis, Genus premium, Clas	9,00
 55	GR710	Membrana - N° 55, 86 Vedi Pag.75	5,00
	CM009	Valvola di sicurezza 3bar in composito - Innesto O.R. Uscita 1/2" M	14,00
	CM002	Scambiatore 14 piastre Attacchi O.R. - Codex, Genus, Es, Microgenus	61,00
	CM013	Scambiatore 16 piastre Attacchi O.R. - Codex, Genus, Es, Microgenus	63,00
	CM001	Scambiatore 14 piastre Attacchi O.R. - Clas, Egis, Genus Premium	46,00
	CN002	Scambiatore 14 piastre Attacchi O.R. Trend, Uno	58,00
	CE003	Estrattore fumi LN200/2C-RO Ventola Ø108, Imbocco Ø58 Vari modelli	169,00

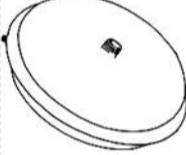
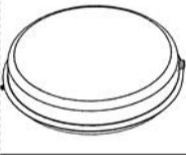
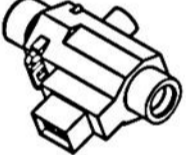
Segue ARISTON/SIMAT/RADI/MTS			EURO
	GR027	Valvola gas Honeywell VK4105/M-2014 ex 2097 Dia, Genus, Codex	215,00
	GR150	Valvola gas Sit SIGMA 845.070 - 3/4" M New Genus, New Codex, Microgenus	120,00
	GR106	Valvola gas Sit NOVA 837.013 Tandem Genus, Codex, Capax	386,00
	CM003	Sonda NTC Verde	7,00
	CR017	Sonda Honeywell a contatto T7335 Uno, Trend	18,00
	CM012	Sonda a contatto Genus, Microgenus, Clas, Rio	7,00
	CM006	Microinterruttore inscatolato Ex, Sp, Re, Arx	27,00
	TZ131	Motore/attuatore ELBI Genus, Genus incasso, Es, Codex, Clas, Egis	27,00

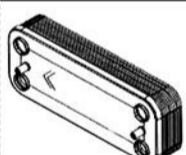
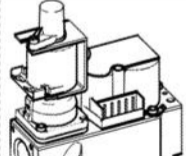
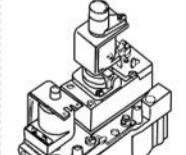
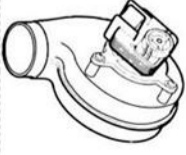
UNICAL**Su richiesta disponibili tutti i ricambi originali**

			EURO
	VE530	Testina di ricambio valvola di sicurezza 3 bar	8,00
	VE531	Testina di ricambio valvola di sicurezza 8 bar	9,00
	VE521	Rubinetto di caricamento	10,00
	TP050	Pressostato sicurezza mancanza acqua - 1/8"M	19,00
	CU003	Gruppo acqua a membrana Attacchi 1/4"M Dua CT prima serie	43,00
	VE113	Vaso espansione lt.10 Ø387mm - 3/4"M centrale Gea Basamento	69,00
	VE115	Vaso espansione lt.8 Ø387mm - 3/8"M Murali istantanee CT	66,00
	TP022	Flussostato magnetico Bitron attacchi 1/2"M Dua, Iven, Enter, Alkon, Eve	24,00
	CH003	Elettrovalvola caricamento CEME - 1/4"M x 1/2"M Enter, Ipsen Entrofuori	40,00
	CI015	Scambiatore 14 piastre Alkon Ink	50,00
	GR003	Valvola gas Honeywell VK4105/N-2013	270,00
	GR021	Valvola gas Honeywell VR4605/NA-2031	240,00
	CE031	Estrattore fumi Ø97 E15-98/GR-RO - Dua 24Kw	120,00
	CE033	Estrattore fumi Ø108 E15-108/GR-RO - Dua 28 Kw	158,00

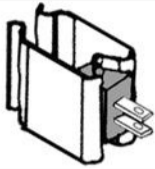
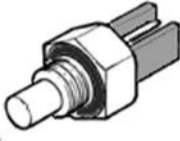
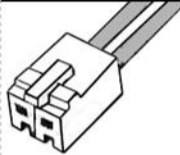

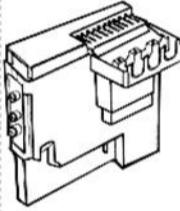
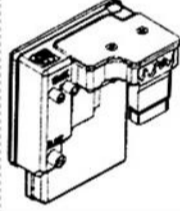
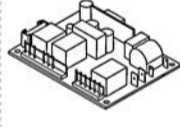
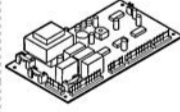

Segue UNICAL

			EURO
	CR017	Sonda temperatura a contatto Honeywell T7335D	18,00
	CU001	Sonda temperatura Verde Con CB006 sostituisce T7335C2008 in ottone	8,00
	CB006	Connettore con cavetti per sonda NTC	5,00
	CU002	Microinterruttore filettato per gruppo acqua Dua CT	20,00
	RA808	Scheda Honeywell S4565AF/1007 Dua CT IN ESAURIMENTO	234,00
	RA809	Scheda Honeywell S4565CD/1039 Cutter	245,00
	RA602	Scheda SIT 537-301 ABC	272,00
	RA821	Scheda di accensione Honeywell S4561A/1007 DUA, GEA	194,00
	RA201	Scheda funzione W4115B/1218 Cutter BSE, Clipper, DUA BTFS, Dua Cargo IN ESAURIMENTO	395,00
	RA202	Scheda funzione W4115B/1192 RSE, DUA CTFS, Cutter CSE IN ESAURIMENTO	213,00

VAILLANT

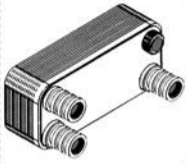
			EURO
	CV005	Premistoppa VCW	5,00
	CV011	Valvola 3 vie motorizzata per VMW	120,00
	CV021	Valvola 3 vie motorizzata per Ecotec Plus 3-5	106,00
	CV020	Cartuccia 3 vie motorizzata VMW serie CS	59,00
	CV017	Motore per valvola 3vie Ecotec, Turbo/Atmoblock	24,00
	CV013	Valvola sicurezza a innesto rapido femmina VMW, VMI	18,00
	CV022	Valvola sicurezza a innesto rapido VM e VMW serie CS	15,00
	CV003	Rubinetto di carico Filetto 1/4M e innesto a O.R. Ecoblock, VMW Plus 2-3-4, Turboplus 2-3-4	19,00
	GR710	Membrana N°15, 66, 84, 85 Vedi Pag.75	5,00
	TZ016	MUT SF25/E - 1" M Valvola 3 vie motorizzata Modelli a basamento	147,00
	CV009	Scambiatore filettato 14 piastre senza raccordi per VCW	66,00
	CV002	Kit scambiatore sanitario a 14 piastre con raccordi per VCW Tecnoblock (Sostituisce lo scambiatore sanitario originale in materiale composito)	100,00
	CV007	Raccordo per adattamento scambiatore CV009 a Modelli VMW- VMW/1	8,00
	CV014	Scambiatore alette 14 piastre Ecoblok Pro, Ecoblok Plus Turboblok Plus	66,00
	CV015	Scambiatore alette 20 piastre Ecoblok Pro, Ecoblok Plus Turboblok Plus	82,00

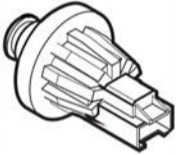
Segue VAILLANT

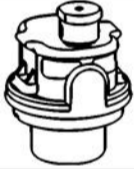
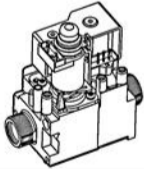
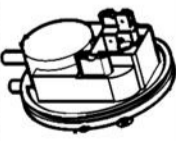
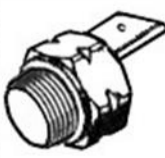
			EURO
	CV010	Scambiatore 14 piastre 3 innesti rapidi - L=190mm VMW3-5- Pro Corto	60,00
	CV016	Scambiatore 20 piastre 3 innesti rapidi - L=190mm VMW3-5- Pro Corto	84,00
	CV012	Scambiatore 14 piastre 3 innesti rapidi - L=205mm VMW3-5- Plus Lungo	75,00
	CV006	Termometro quadrato VCW	46,00
	TP020	Sensore portata 1/2" M Honeywell C7195A/2001 (Flussometro) per Mag Turbo	34,00
	CV018	Trasduttore di pressione Ecotec, Turboblock, Atmoblock	21,00
	CV019	Flussostato rotativo Nuova Ecoblock, EcoTec, Turbo/Atmoblock	33,00
	VE480	Valvola sfiato Caleffi plastica innesto rapido pompe Wilo e Grundfos	10,00
	GR023	Valvola gas Honeywell VK4105/M2055 Intercambiabile VK4115/M2039, 2054 e 2062	370,00
	GR171	Valvola gas SIT SIGMA 848.107 Attacchi filettati 3/4" M Modelli a condensazione	186,00
	CE009	Estrattore LN250/2C-RO Imbocco 52x60mm - 28 kW Adattabile VCW, VMW1	115,00
	GP019	Pressostato fumi Huba Control 1,00/0,72mbar	30,00
	CV004	Sonda temperatura VCW	10,00

Segue VAILLANT

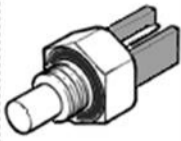
			EURO
	CF001	Sonda NTC verde Basamento	8,00
	RA811	Scheda Honeywell S4565TM/1021B per MAG20 IN ESAURIMENTO	332,00
	RA611	Scheda Sit 579-604 DBC (ex 577.604, ex 577.603) Per caldaie a condensazione	325,00







CHAFFOTEAUX**Su richiesta disponibili tutti i ricambi originali**

			EURO
 51	GR710	Membrana N° 25, 43, 51, 58, 59, 65 Vedi Pag.75	5,00
	CM009	Valvola di sicurezza 3bar in composito - Innesto O.R. Uscita 1/2" M	14,00
	CO006	Rubinetto di caricamento Alixia, Pigma, Talia, Urbia	9,00
	CO007	Scambiatore sanitario 14 piastre Adattabile Nectra, Elexia, MC, Centora	60,00
	CN002	Scambiatore 14 piastre O.R. Adattabile Elexia confort, Compy, Calidra I° serie	58,00
	CM001	Scambiatore 14 piastre Attacchi O.R. - Niagara C, Alixia, Pigma, Urbia, Thalia	46,00
	CC023	Flussostato SIRAM Adattabile Calidra/Nectra	66,00
	CC024	Motore valvola 3 vie Adattabile Nectra	65,00
	CM008	Cartuccia 3vie Alixia, Pigma, Talia, Urbia	20,00
	CC015	Sonda temperatura nuovo tipo Attacco rapido OR Calidra, Nectra, Maya	11,00
	CM012	Sonda a contatto Mira, Niagara, Talia, Urbia, Centora	7,00

FONDITAL/NOVA FLORIDA**Su richiesta disponibili tutti i ricambi originali**



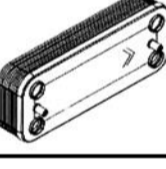
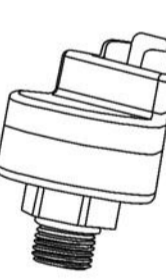
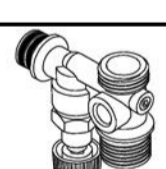

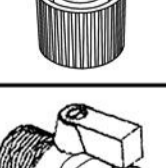

			EURO
	VE521	Rubinetto di carico 37 mm Vela - Panarea	10,00
	VE528	Rubinetto di carico 60 mm Tahiti, Pictor	11,00
	TP018	Flussostato 3/4" M Per caldaie murali a condensazione	78,00
	TP050	Pressostato sicurezza mancanza acqua 1/8" M	19,00
	CN002	Scambiatore 14 piastre attacchi O.R. Pictor, Formentera	58,00
	CM002	Scambiatore 14 piastre attacchi O.R. Ischia, Delfis	61,00
	VE524	Valvola sicurezza 3 bar Attacco O.R.	10,00
	TP022	Flussostato magnetico Bitron attacchi 1/2" M	24,00
	GP010	Pressostato fumi Huba Control 0,47/0,35mbar	30,00
	GR150	Valvola gas Sit SIGMA 845.070 Attacchi 3/4" M Panarea, Tahiti, Pictor, Delfis	120,00
	TZ131	Motore/Attuatore ELBI	27,00
	GR906	Valvola gas 25M42M Fondital New Gazelle, Windor Classic, Techno	138,00
	RA707	Quadro elettrico Fondital Techno, Windor classic	260,00
	CN011	Solenioide e bobina bipotenziiale Fondital Gazelle, Windor	75,00

FERROLI/FER

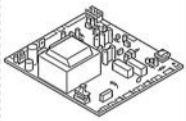



			EURO
	TP009	Flussostato a paletta Caleffi NAV Attacchi 1/2" M	58,00
	TP020	Sensore di portata 1/2" M Honeywell C7195A/2001 (Flussometro)	34,00
	TP024	Flussometro Eltek Attacchi 1/2" M Diva Top, Ferdigit, Fersystem	30,00
	TP021	Sensore di portata Caleffi 1/2" M in ottone (Flussometro)	33,00
	TP023	Sensore portata ad angolo 1/2" M in ottone (Flussometro)	48,00
	CI008	Termoidrometro Bianco Foro Ø40mm Attacco 1/4" M	21,00
	CF005	Scambiatore a piastre attacchi filettati 1/2 MF - 3/4" MF 14 piastre	60,00
	CN002	Scambiatore a O.R. 14 piastre Econcept	58,00
	CF008	Trasduttore di pressione Attacco filettato 1/4" M	27,00
	CF009	Trasduttore di pressione Attacco O.R.	27,00
	CF010	Gruppo di caricamento Domina, Igloo, Domitop DGT	33,00
	CF011	Gruppo di caricamento Domicompact, Ferella Zip	33,00
	CF014	Gruppo di caricamento Domitop, Ferella Gold	26,00
	CF013	Rubinetto di caricamento 1/2" M - 3/4" M	58,00

Segue FERROLI/FER			EURO
	VE480	Valvola sfiato Caleffi in plastica innesto rapido pompe Wilo e Grundfos	10,00
	CF006	Motore per valvola 3vie Motorizzata - Fersystem, Diva Top, Ferdigit, Econcept	84,00
	GR029	Valvola gas Honeywell VK4105/G-1070 Attacco 1/2" M + flangia	198,00
	GR801	Termocoppia ASA mm.750 doppio dado	15,00
	CE007	Estrattore fumi 250/2C-RA Imbocco 52x60mm Caldaie 24KW	70,00
	GP010	Pressostato fumi Huba Control 0,47/0,35mbar	30,00
	CF012	Kit venturi estrattore fumi in plastica	25,00
	RA128	Apparecchiatura Brahma SM191.2	153,00
	RA818	Scheda Honeywell S4565DM/1003 (ex 1060) Domina Insert, Igloo IN ESAURIMENTO	202,00
	RA819	Scheda Honeywell S4564BF/1006 Pegasus F3	183,00
	RA232	Scheda modulazione MF03F.1 (S4562DM1022) Domina, Domina Plus	215,00

Segue FERROLI/FER

			EURO
	RA233	Scheda modulazione MF08FA - SM16501 Domicompact, Ferella Zip	320,00
	RA234	Scheda modulazione DBM01A - SM16503 Domiproject, Domininsert	368,00
	CF001	Sonda temperatura Verde PTC	8,00
	CF002	Sonda temperatura Colore neutro Tipo Domina	7,00
	CF003	Sonda a contatto a bracciale Ø15mm	7,00
	CR017	Sonda temperatura a contatto Honeywell T7335	18,00
	CF004	Sonda temperatura a Contatto 4 fili Sonda + sicurezza	24,00

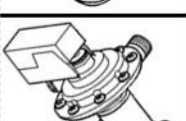
SILE**Su richiesta disponibili ricambi originali**



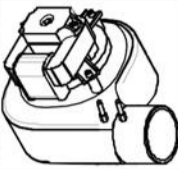
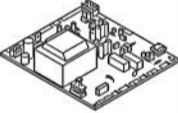

			EURO
	TP021	Flussometro 1/2" M Caleffi 316 Superapida	33,00
	TP018	Flussostato 3/4" M Per caldaie murali a condensazione	78,00
	TP050	Pressostato sicurezza mancanza acqua - 1/8" M	19,00
	TP203	Valvola Giannoni 3vie Turbinox	178,00
	GR027	Valvola gas Honeywell VK4105/M-2014 Superapida Turbinox	215,00
	GR026	VK4105/M-5017 moduleg	233,00

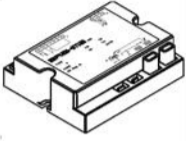
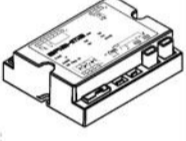

Segue SILE			EURO
	CE002	Estrattore fumi LN200 Con venturi Modelli Bi-TBi	169,00
	CE015	Estrattore fumi con venturi e staffa - AACO ET22 SUPERAPIDA 23	152,00
	CE016	Estrattore fumi con venturi e staffa - AACO ET25 SUPERAPIDA 31	156,00
	TZ131	Motore/attuatore ELBI Mod. Condensa	27,00
	RA245	Schedone Brahma 16020900 - Istantanee	369,00
	RA246	Schedone Brahma 16020910 - Con bollitore	380,00
	RA244	Scheda funzione Bertelli LC06N	252,00
	RA247	Scheda funzione Bertelli MLC02.01	246,00
	RA248	Scheda Bertelli DIMS16-S01	252,00
	RA249	Scheda Bertelli DIMS16-S02	268,00
	RA651	Scheda accensione FM31 Bertelli & P. (Sost.FM25) Turbinox - SA -Superapida	160,00
	CI003	Sonda temperatura rossa Corpo ottone (ex grigia)	6,00

APPARECCHIATURE E SCHEDE ELETTRONICHE

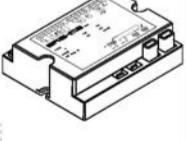

BRAHMA

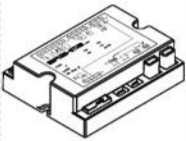
Serie EUROFLAT/MINIFLAT

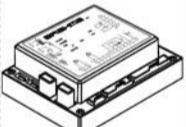
			EURO
	RA151	CE11 - Tw 20" Ts 5" Riarmo automatico Generatori pensili	115,00
	RA150	CE31 - Tw 30" Ts 10" Riarmo automatico Generatori pensili	127,00
	RA139	CM11 - Tw 1,5" Ts 10" Ici, Immergas, Bongioanni, Riello	127,00
	RA142	CM11 - Tw 30" Ts 10" Accorroni	129,00
	RA159	CM11/O - Tw 1,5" Ts 10" Immergas	140,00
	RA137	CM11/F - Tw 1,5" Ts 10" Immergas	136,00
	RA160	CM11F/O - Tw 1,5" Ts 10" Immergas	144,00
	RA144	CM31/F- Tw 1,5" Ts 10" Immergas Intercambiabile CM31/U	138,00
	RA161	CM31/F- Tw 20" Ts 10" Radiatori a gas, tubi radianti	140,00
	RA146	CM31 - Tw 1,5" Ts 10" Immergas, Riello, Sile, Joannes	137,00
	RA143	CM31 - Tw 30" Ts 10" Accorroni	139,00
	RA152	CM32/PR - Tw 30" Ts 10" Robur	120,00
	RA136	DTM31/PR Tw 30" - Ts 10" Robur	170,00

			EURO
	RA140	CM32 - Tw 1,5" Ts 10" Immergas, Gruppo IMAR	143,00
	RA148	CM32 - Tw 30" Ts 10" Accorroni, Apen Group, Riello	152,00
	RA141	CM32 - Tw 1,5" Ts 60" Sylber	154,00
	RA147	CM32/CSP A.R. Tw 5" Ts 30" Gruppo Imar, Sime	197,00
	RA114	FM11 - Tw 1,5" Ts 10" Sime	137,00
	RA149	FM31 - Tw 5" Ts 10" Sime camera stagna	158,00
	RA138	SM11 - Tw 1,5" Ts 10" Beretta, Immergas, Bongioanni	138,00
	RA145	SM11 - Tw 5" Ts 60" Gruppo Imar	138,00
	RA156	TM11 - Tw 1,5" Ts 10" Joannes, Finterm, Arca	121,00
	RA157	TM12 - Tw 1,5" Ts 10" Riello IN ESAURIMENTO	123,00
	RA158	TM31 - Tw 1,5" Ts 10" Joannes, Finterm, Arca Sostituisce Bertelli FM11	142,00

CONNETTORI

			EURO
	RA251	Connettore multipoli per BRAHMA CM/SM Varie misure	3,00
	RA253	Terminale ad aggirare BRAHMA CM/SM Confezione Pz.10	3,00

HONEYWELL serie S45...

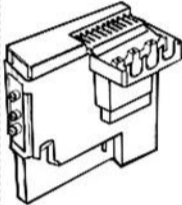
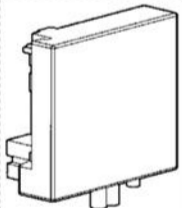
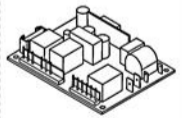
			EURO
	RA803	S4585D/1011 Sylber, Riello IN ESAURIMENTO	182,00
	RA807	S4565CF/1045 (ex 1052,1078) Riello basamento, Sime, Savio, Lamborghini	293,00
	RA808	S4565AF/1007 (ex 1064, 1056) Unical, Saunier Duval, Riello Domus IN ESAURIMENTO	234,00
	RA809	S4565CD/1039 - (ex 1021) Unical, Hermann	245,00
	RA811	S4565TM/1021 Vaillant MAG20 IN ESAURIMENTO	332,00
	RA825	S4565C/1025/V01 Apen Group	242,00
	RA826	S4565DM/3094 Apen Group IN ESAURIMENTO	335,00
	RA805	S4565A/2019 Radiant, FBR, Blowtherm, Farel	226,00
	RA818	S4565DM/1003 (ex 1060) Fer, Ferroli IN ESAURIMENTO	202,00
	RA819	S4564BF/1006 Fer, Ferroli	183,00
	RA821	S4561A/1007 Unical	194,00

SIT

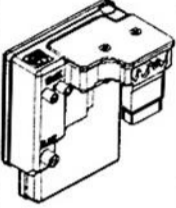
			EURO
	RA600	537-002 ABC (Ex 507) Riello, Beretta	291,00
	RA602	537-301 ABC (ex 507) Unical, Hermann, Sime, Adattabile Comex 537.309	272,00
	RA603	537-401 ABC (Ex 507) Savio, Biasi	350,00
	RA604	537-403 ABC (Ex 507) Fraccaro	325,00
	RA611	579-604 DBC (ex 577.604, ex 577.603) HSD e Vaillant condensazione	325,00

BERTELLI & PARTNERS

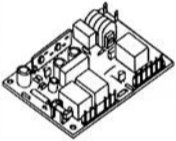
			EURO
	RA651	FM31 (Sostituisce FM19/25/37) Immergas, Sile, Rhoss Intercambiabile Brahma CM31	160,00
	RA226	FT14 - Adattabile Hermann Laser 24-29 E, Lamborghini Inova	149,00

DISSOLIDANTE Spray per contatti

			EURO
	SA356	CHEM SP17 ml.400 Solvente per elettronica Elimina lo sporco senza lasciare residui né aggredire i materiali di supporto	30,00

FUSIBILI - Confezioni Pz. 10

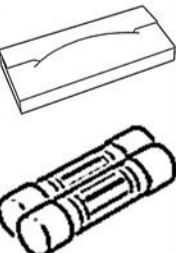

			EURO
	FA001	Fusibili 315 mA	4,00
	FA002	Fusibili 500 mA	4,00
	FA003	Fusibili 1 A	4,00
	FA004	Fusibili 2 A	4,00
	FA005	Fusibili 3,15 A	4,00
	FA006	Fusibili 4 A	4,00

BRAHMA

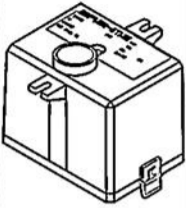
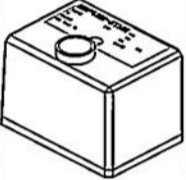
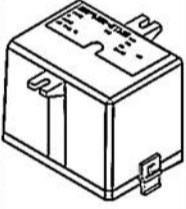
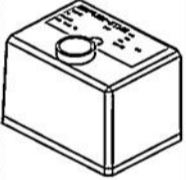
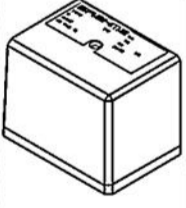

Serie EUROBOX

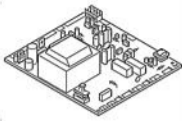
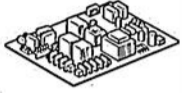
			EURO
	RA112	SM191.1 - Tw 1,5" Ts 10" Riello, Beretta, Sime, Joannes, Savio, Finterm	154,00
	RA118	CM191.1 - Tw 1,5" Ts 10" Apen Group IN ESAURIMENTO	129,00
	RA128	SM191.2 - Tw 1,5" Ts 10" Fer, Ferroli, Ctmc, Fais, Pensotti	153,00
	RA131	CM191.2 - Tw 1,5" Ts 10" Sime, Lamborghini, Riello Pensotti, Joannes, Ctmc	137,00
	RA134	SM192.2 - Tw 1,5" Ts 10" Apen Group, Chaffoteaux	152,00
	RA133	CM191.3 - Tw 1,5" Ts 10" Unical IN ESAURIMENTO	123,00
	RA117	CM391.2 - Tw 1,5" Ts 10" Riello, Baltur, Ctmc, Sime, Pensotti	161,00
	RA111	SM152.2 - Tw 30" Ts 10" Può sostituire IONO700/800 Con modifiche al cablaggio Robur pensili	156,00
	RA153	CM381.4 - Tw 30" Ts 5" Ctmc IN ESAURIMENTO	153,00
	RA154	CE191.4 - Tw 30" Ts 10" Riarmo automatico Tubi radianti, Fraccaro	117,00
	RA155	CE391.4 - Tw 30" Ts 10" Riarmo automatico Tubi radianti, Fraccaro	142,00

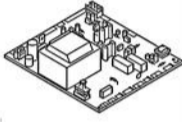
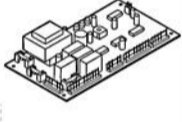
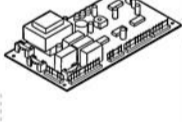
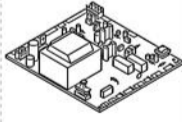
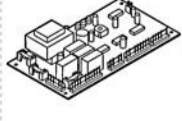
SCHEDE DI MODULAZIONE

			EURO
	RA222	SM07407 Hermann Micra2 (fino al 2009)	240,00
	RA223	SM07414 con display Hermann Thesi, Thesi condensing	303,00
	RA232	MF03F.1 (S4562DM1022) Ferrolì Domina, Domina Plus	215,00
	RA233	MF08FA - SM16501 Ferrolì Domicompact, Ferella Zip	320,00
	RA234	DBM01A - SM16503 Ferrolì Domiproject, Dominsert	368,00
	RA201	W4115B/1218 Unical DUA BTFS, Dua Cargo, Clipper, Cutter BSE IN ESAURIMENTO	395,00
	RA202	W4115B/1192 Unical DUA CTFS, Cutter CSE, RSE IN ESAURIMENTO	213,00
	RA245	Schedone Brahma 16020900 Sile	369,00
	RA246	Schedone Brahma 16020910 Sile con bollitore	380,00
	RA244	Scheda funzione Bertelli LC06N Sile	252,00
	RA247	Scheda funzione Bertelli MLC02.01 Sile	246,00
	RA248	Schedone Bertelli DIMS16-S01 Sile	252,00
	RA249	Schedone Bertelli DIMS16-S02 Sile	268,00

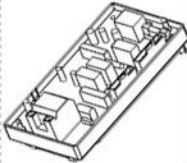
APPARECCHIATURE x Radiatori a gas

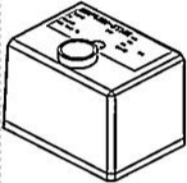
			EURO
	RA707	Quadro elettrico Fondital Techno Windor classic	260,00
	RA705	Quadro elettrico Robur Supercromo	168,00
	RA152	CM32/PR - Tw 30" Ts 10" Robur	120,00
	RA136	DTM31/PR - Tw 30" - Ts 10" Robur	170,00
	RA111	SM152.2 - Tw 30" Ts 10" Può sostituire IONO700-800 Con modifiche al cablaggio Robur pensili	156,00





RESISTENZE PER SCALDABAGNI ELETTRICI

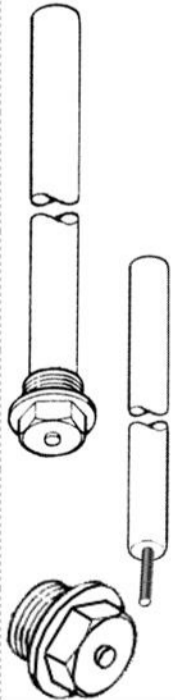



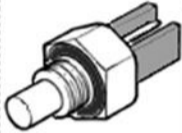

			EURO
	RS002	Resistenza 1000W Filetto 1"1/4, cm.30	30,00
	RS003	Resistenza 1500W Filetto 1"1/4, cm.30	30,00
	RS004	Resistenza 2000W Filetto 1"1/4, cm.40	32,00
	RS001	Termostato regolabile MGR cm.27 regolabile 10/80°C	16,00

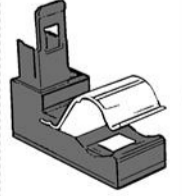
ANODI AL MAGNESIO

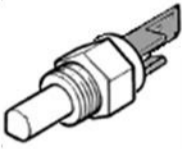
			EURO
	RS100	Anodo Ø 21 x L=300 mm Tappo 3/4"M e filetto M8	18,00
	RS101	Anodo Ø 21 x L=400 mm Tappo 3/4"M e filetto M8	21,00
	RS102	Anodo Ø 26 x L=320 mm Tappo 1"M	24,00
	RS105	Anodo Ø 32 x L=320 mm Tappo 1"1/4M	54,00
	RS104	Anodo Ø16 x L=600 mm Filetto 4ma - Adattabile Immergas	15,00
	RS103	Tappo 1/2"M filetto 4ma Per anodo RS104	4,00

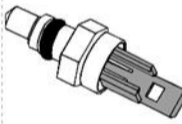
SONDE DI TEMPERATURA

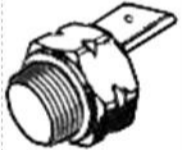
			EURO
	CB003	Verde Biklim, Roca	7,00
	CT001	Verde Finterm, Euroterm, ICI, Joannes	7,00
	CU001	Verde NTC 10K Unical	8,00
	CF001	Verde PTC 1K Fer, Ferroli	8,00
	CM003	Verde Merloni, Ariston, Simat, Radi, Ecoflam	7,00
	CS001	Verde Savio, Roca, Biasi, Idealclima	7,00
	CF002	Neutra Ferroli Domina	7,00
	CR017	Rossa contatto Honeywell T7335D1008 (Sost.1016) Beretta, Unical, Ferroli, MTS	18,00
	CM012	A contatto clip Ø18mm Ferroli, MTS, Chaffoteaux	7,00
	CF003	A contatto clip Ø15mm Ferroli	7,00
	CF004	Sonda temperatura a contatto 4 fili Lamborghini, Ferroli, Joannes	24,00
	CN003	Nordgas a contatto clip Ø14mm Immergas, Sile, Radiant, Fondital	8,00
	CN004	Nordgas a contatto clip Ø18mm Immergas, Sile, Radiant, Fondital	8,00

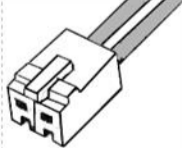
			EURO
	CM005	Rossa Beretta, Riello, Hermann, Merloni, Baltur, Immergas	6,00
	CO010	Bianca Baxi, Hermann, Immergas	6,00
	CI003	Rossa e ottone (ex grigia) Immergas, Sime, Sile	6,00
	CR010	Blu Riello, Beretta, Ocean, Radiant, Hermann	6,00
	CI001	Nera Riello, Beretta, Immergas, Ocean, Radiant, Lamborghini	6,00
	CR016	Blu O.R. Riello, Beretta, Baxi, Sime Murelle	12,00
	CI009	Rossa O.R. Immergas	12,00
	CS002	Nera O.R. Savio	6,00
	CC015	Ottone O.R. Chaffoteaux nuovi modelli	11,00
	CV004	Speciale Vaillant VCW	10,00
	CX002	Sanitario e riscaldamento Viessmann Vitodens e Vitopend	9,00
	TY250	Brahma ST07 a immersione NTC 10K - Cavo mt.1,75 Per bollitori	17,00
	CB006	Connettore con cavetti per sonda NTC (Specificare tipo di sonda)	5,00

ELETTROVALVOLE GAS**HONEYWELL VK C.V.I.**

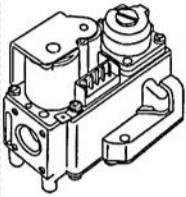
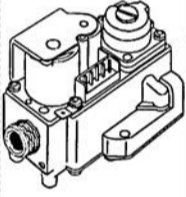
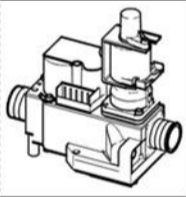
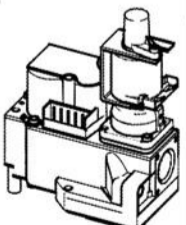
		EURO	
	GR018	VK4100/C-1000 con uscita pilota Beretta, Sylber, Unical	155,00
	GR012	VK4105/A-1027 (Ex 1050) Beretta, Riello, Radiant Adatt. Immergas, Hermann, Sime	223,00
	GR017	VK4105/A-1035 - 1/2" F Adattabile VK4105M-2048 Radiant, Hermann, Blowtherm	174,00
	GR013	VK4105/C-1009 (Ex 1025) Immergas, Kalard, Sylber Adattabile Unical, Ici	210,00
	GR029	VK4105/G-1070 1 attacco 1/2" M Fer, Ferroli	198,00
	GR030	VK4105/G-1112 Attacchi 1/2" M Radiant, FBR, Blowtherm	163,00
	GR028	VK4105/G-1005 Beretta, Radiant, Riello, Unical, Blowtherm	327,00
	GR031	VK4105/G-1138 Attacchi 3/4" M Radiant, FBR, Apen Group, Blowtherm	198,00
	GR024	VK4105/M-2105 Modureg 17Vcc Filetti 3/4" M - Hermann	335,00
	GR023	VK4105/M-2055 Modureg 17Vcc Immergas, Sime, Joannes Intercambiabile VK4115/M-2039, 2054 e 2062 per Vaillant	370,00
	GR015	VK4105/M-2048 Modureg Filetti 1/2" F - Hermann	323,00
	GR026	VK4105/M-5017 Modureg Sime, Sile	233,00
	GR027	VK4105/M-2014 Modureg (Ex 2097) - Sile, MTS	215,00
	GR014	VK4105/M-2071 Modureg Saunier Duval	360,00
	GR022	VK4105/M-5108 Modureg Baxi Luna-Eco	176,00
	GR003	VK4105/N-2013 Modureg Unical, Sile, Ferroli, Ici, Sylber	270,00

HONEYWELL automatiche

			EURO
	GR008	VR4605/AA-1003 Beretta, Immergas Adattabile Ocean	354,00
	GR009	VR4605/CA-1027 (Ex 1068) Unical, Ferroli, Immergas, Cosmogas Adattabile Ici, Sime, Savio, Sile, Radiant, Lamborghini	340,00
	GR021	VR4605/NA-2031 moduleg 28 Vcc Unical	240,00

HONEYWELL IN ESAURIMENTO

			EURO
	GR001	V4600/C-1193 - 1/2" Ex 1029 Fiamma pilota IN ESAURIMENTO	414,00
	GR006	VR4705/C-4013 - Radiant Immergas, Cosmogas, Adattabile Ferroli e Vaillant IN ESAURIMENTO	285,00
	GR007	VR4705/A-4023 Immergas, Beretta, Riello IN ESAURIMENTO	285,00

- Modelli VR-VK/N e/O
Adattabili con VR/C
(Apertura lenta)
- Modelli VR-VK/M e/P
Adattabili con VR/A
(Apertura rapida)

0 = con uscita per pilota
1 = con uscita per pilota
5 = senza uscita per pilota

Classe degli operatori
0 = classe B+D
1 = classe B+C
2 = classe B+B
3 = classe A+D
4 = classe A+C
5 = classe A+B
6 = classe A+A

V = valvola elettropilostatica
VR = valvola automatica
VS = valvola pilostatica
VK = C.V.I.

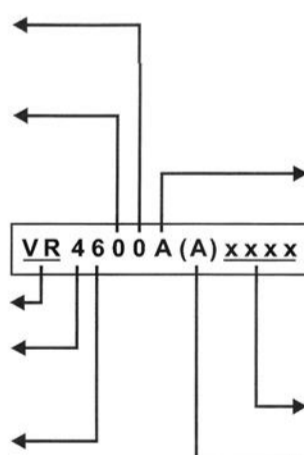

4 = tensione di rete (220 o 220-240Vac)
8 = bassa tensione = 24Vac

4 = I.C.G.I. (V4400)
6 = Compact (V/VR/4600/8600)
7 = M.N. (V/VR/4700/8700)
9 = Dual (V/VR/4900/8900)
1 = C.V.I. (VK4100)
8 = I.C.G.C a bassa tensione

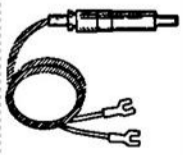

A = apertura rapida con regolatore
B = apertura rapida senza regolatore
C = apertura lenta con regolatore
D = apertura lenta senza regolatore
E = apertura rapida con riduzione di portata
G = apertura rapida con doppio regolatore
H = apertura lenta con Modulec
M = apertura rapida con Moduleg
N = apertura lenta con Moduleg
P = apertura rapida con High-low
Q = apertura lenta con High-low
T = apertura lenta con regolazione di portata
R = apertura rapida con possibilità di rapporto aria/gas
V = apertura rapida con regolazione 1:1 aria/gas
Numero identificativo
A = bassa portata
B = alta portata

Ricambi ed accessori HONEYWELL

			EURO
	GR051	Q313A - Termopila per VS8820A - Cavi 900 mm	192,00
	GR025	Connettore raddrizzato per VK4105/...	27,00

SIT serie Sigma 848

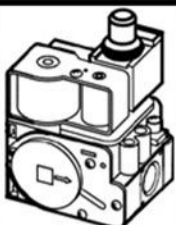
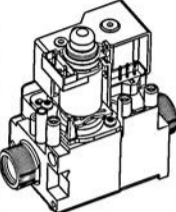
			EURO
	GR170	SIGMA 848.054 Flangiata Baxi Luna HT	210,00
	GR173	SIGMA 848.079 Flangiata Sile condensa	255,00
	GR171	SIGMA 848.107 3/4" M Hermann, Vaillant	186,00
	GR172	SIGMA 848.160 3/4" M (Ex 022) Riello, Beretta	235,00

SIT serie Sigma 845

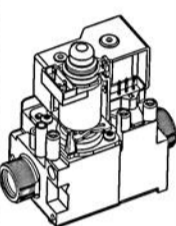
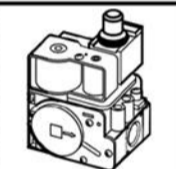
			EURO
	GR150	SIGMA 845.070* - 3/4" M Riello, Sime, Hermann, Rhoss, Ariston, Unical, Robur, Tata	120,00
	GR151	SIGMA 845.063 (ex 109) 3/4" M - Immergas, Baxi Intercambiabile 845.012 Hermann	120,00
	GR152	SIGMA 845.131 (ex 048) Flangiata Baxi	228,00

***Il modello SIGMA 845.070 puo' sostituire
i modelli 845.057, 845.058 e 845.108**

SIT automatiche

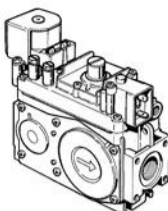
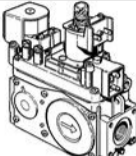

			EURO
	GR116	NOVA 830.035 - 1/2" (ex 034) Portata e L.A.regolabili	221,00
	GR118	NOVA 830.030 - 1/2" - Pilota Portata e L.A.regolabili IN ESAURIMENTO	234,00
	GR142	NOVA 832.030 - 1/2" Bobine in classe A Portata e L.A.regolabili Per bruciatori pot.>70kW	364,00
	GR113	NOVA 836.010 - 1/2" Modulazione a gradino 230V Ecoflam, Robur	386,00
	GR110	NOVA 837.010 - 1/2" Bobina modulante 16V CC	386,00
	GR106	NOVA 837.013 Tandem Bobina modulante 28Vcc MTS, Ariston	386,00

			EURO
	GR130	NOVA 822.110 - 1/2" Intercambiabile 822.114	372,00
	GR103	NOVA 826.011 - 1/2" Modulazione a gradino 230V Lamborghini, Vaillant, Robur	453,00
	GR111	NOVA 827.111 - 1/2" Bobina modulante 28V CC Ferrolì, Sime, Unical	447,00

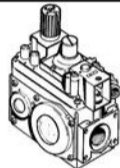
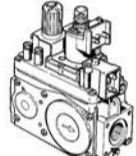
SIT elettropilostatiche

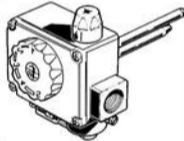

			EURO
	GR107	NOVA 820.011 - 1/2"F	285,00
	GR131	NOVA 825.011 - 1/2"F Bobina modulante 28V CC	385,00

SIT per scaldabagni, radiatori e stufe

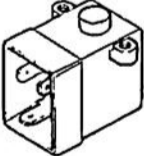
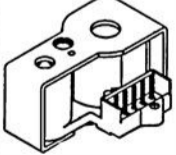
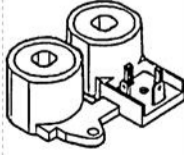
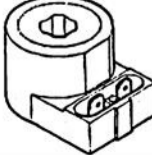

			EURO
	GR105	AC3 610.001 IN ESAURIMENTO	374,00
	GR122	EUROSIT 630.100 Regolazione bulbo 40/72°C	217,00
	GR125	EUROSIT 630.011 Regolazione bulbo 13/38°C	217,00

Ricambi ed accessori SIT

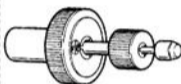
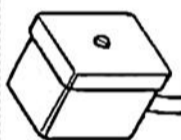
			EURO
	GR119	Bobina EV2 operatore per NOVA 820, 822, 824, 825, 826, 827	63,00
	GR146	Bobine operatore EV1 per 845, 848 Sigma	88,00
	GR124	Bobina operatore doppia per mod. 830, 832, 837	152,00
	GR126	Bobina EV1 operatore per NOVA 822, 826, 827	52,00

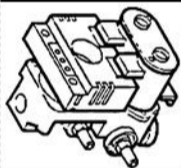

			EURO
	GR143	Bobina modulatore 28V CC blu per 825, 827, 837	64,00
	GR144	Bobina modulatore 16V CC bianca per 825, 827, 837 IN ESAURIMENTO	47,00
	GR145	Bobina modulatore 220V RAC nera/verde per modelli 825, 826, 827, 836, 837	53,00
	GR138	Cartuccia metano 2-20mbar Bianca - 825, 827, 837 IN ESAURIMENTO	67,00
	GR139	Cartuccia multigas 3-37mbar Rossa - 825, 827, 837 IN ESAURIMENTO	67,00
	GR160	Chiave di regolazione SIT IN ESAURIMENTO	52,00
	GR127	Connettore con cavo cm.100 per modelli 830 - 832 - 837	41,00

WHITE RODGERS - Radiatori e scaldabagni

			EURO
	GR906	Elettrovalvola 25M42M-13a* Universale Sostituisce 02a, 12a, 15a, 16a	138,00
	GR907	Ponte rettificatore universale per 13a	15,00

**ATTENZIONE! Il modello 73a è fuori produzione
e NON può essere sostituito col modello 13a!**

Ricambi ed accessori WHITE RODGERS

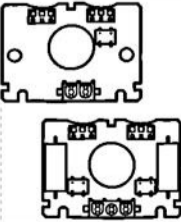
			EURO
	GR910	Bobina 110V - Terminali a spillo (Per 12a-15a-16a)	35,00
	GR911	Bobina 220V - Terminali a spillo (Per 73a)	38,00
	GR912	Bobina 110V - Terminali a faston (Per 5a - 13a)	33,00
	GR905	Schedina raddrizzatore Specificare connettore: 2 pin x bobine GR910 3 pin x bobine GR911	54,00

BRUCIATORI PILOTA

			EURO
	GR010	Bruciatore pilota Q334/A Honeywell	25,00
	GR135	Bruciatore pilota Monogas 3 fiamme verticali Tipo A IN ESAURIMENTO	19,00
	GR136	Bruciatore pilota Monogas 3 fiamme verticali - Staffa L Tipo B IN ESAURIMENTO	14,00
	GR115	Bruciatore pilota universale 1 fiamma 2 impronte IN ESAURIMENTO	12,00
	GR132	Bruciatore pilota universale 2 fiamme 2 impronte IN ESAURIMENTO	12,00
	GR016	Ugello pilota MTN	11,00
	GR019	Ugello pilota GPL	23,00
	RN142	Tubo rame x tubo pilota Ø6x4mm - Matassa mt.2,5	28,00
	GR129	Raccordo pilota con bicono Ø6mm (Specificare ASA/SIT)	3,00
	GR140	Ogive per bicono Ø6mm Confezione pz.10	24,00
	GR500	Kit 12 Alesatori per ugelli	90,00

ACCENDITORI E TRASFORMATORI

			EURO
	GR571	Accenditore piezoelettrico Ø18mm	9,00
	GR572	Accenditore piezoelettrico Ø22mm	17,00
	GR137	Accenditore piezoelettrico per scaldabagni	17,00
	RT015	COFI TRK2 - 100% 2 poli x 12KV - 35mA Cosmogas serie "dens"	40,00
	GR325	Accenditore HT 15kV - 230V BRAHMA TSM	28,00
	GR330	BRAHMA AR1 Amplificatore della corrente di ionizzazione	39,00

TERMOCOPPIE**Universali in busta**

			EURO
	GR202	BASE - mm.900 5 raccordi	18,00
	GR121	SIT 208.002 - mm.900 8 raccordi	19,00
	GR205	DOUBLE interrotta bifilare 8 raccordi - L=mm.900 Cavi a saldare L=mm.750	34,00

TERMOCOPPIE specifiche

			EURO
	GR811	ASA mm.750 doppio dado Giunto Honeywell - Sile	36,00
	GR801	ASA mm.750 doppio dado Giunto Ferrolì	15,00

Prolunghe ed accessori

			EURO
	GR805	Prolunga termocoppia ASA mm.450	18,00
	GR804	Prolunga termocoppia SIT mm.600	8,00



TERMOCOPPIE Unificate**Passo SIT M9x1**

			EURO
	GR502	mm.320	7,00
	GR503	mm.600	9,00
	GR504	mm.850	9,00





Passo ASA/Honeywell

			EURO
	GR512	mm. 450	8,00
	GR513	mm. 600	9,00
	GR514	mm. 850	9,00
	GR515	mm. 1500	10,00

RACCORDI

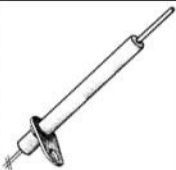
			EURO
	GR523	Raccordo fresato M8x1	3,00
	GR522	Raccordo fresato M9x1 SIT	3,00
	GR524	Raccordo fresato M10x1	3,00
	GR526	Raccordo fresato M11x1	3,00
	GR525	Raccordo fresato 11/32" ASA/Honeywell	3,00
	GR527	Raccordo fissaggio termocoppie M10x1	3,00
	GR555	Raccordo interrotto M9x1 Faston 6,3mm IN ESAURIMENTO	10,00
	GR556	Raccordo interrotto ASA Faston 6,3mm IN ESAURIMENTO	10,00

CANDELETTE DI ACCENSIONE E RILEVAZIONE

			EURO
	GR560	Candela Ø7 x 85 mm con cavo mm.700 e staffa	10,00
	GR559	Candela Ø6,5 x 65 mm con staffa Innesto minifaston	12,00
	GR563	Candela Ø7 x 85 mm con staffa tipo Immergas Innesto Ø4mm	10,00
	GR011	Candela Ø6,5 x 65,5 mm con cavo mm.500 per pilota Honeywell Q334A	12,00
	GR561	Candela Ø6,5 x 65,5 mm Innesto minifaston	10,00
	GR141	Raccordo fissaggio candeletta	3,00
	GR117	Cavetto candeletta-piezo mm.600 Terminali Ø2,4mm - Ø4mm	6,00

MANTELLI COPRICALDAIA

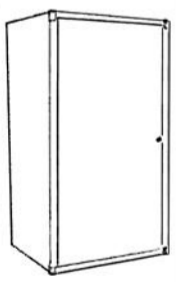
			EURO
	AR201	F55 H1000 x L550 x P440 mm	292,00
	AR202	F60 H1060 x L600 x P440 mm	350,00
	AR203	F65 H1220 x L650 x P440 mm	397,00
	AR204	F70 H1120 x L700 x P510 mm Per caldaie con accumulo	427,00

Lamiera preverniciata con coibentazione in lana di vetro Termover di spessore 20mm.

Fornito in kit di montaggio.

N.B. Le misure riportate sono esterne.

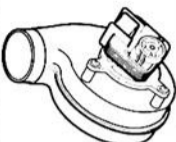
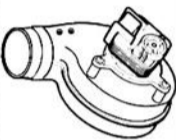
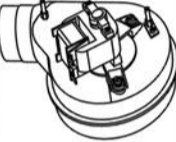
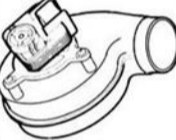

ESTRATTORI FUMI**Imbocco rotondo Ø56 mm**

			EURO
	CE031	E15-98/GR RO Ventola Ø97 Unical, Cosmogas, Rhoss, Radiant, Lamborghini, Saunier Duval, Leblanc, Ferrol Domina 24, Ariston	120,00
	CE033	E15-108/GR RO Ventola Ø108 Unical, Sile	158,00
	CH001	Estrattore fumi EBM G2K097 RO Ventola Ø97 con fori venturi Hermann, Idealclima	100,00
	CE034	FIME GR800 RO - Ventola Ø97 Completo di boccaglio e 2 prese venturi pressostato	75,00
	CE032	E15-98/DR RA Ventola Ø97 SaunierDuval, Sime	117,00
	CE011	RLG108 RA Ventola Ø108 Baxi Luna, Eco 240	108,00

Imbocco rotondo Ø58 mm

			EURO
	CE003	LN200/2C-RO Ventola Ø108 Bongioanni, Ariston, Simat, Rhoss, Sile	169,00
	CE004	LN200/2C-RA Ventola Ø108 Immergas, Sime	124,00

Imbocco rotondo Ø60 mm

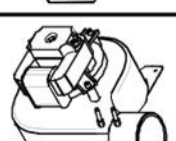
			EURO
	CE002	LN200 con venturi Sile	169,00
	CE015	AACO ET22 con venturi e staffa Sile	152,00
	CE016	AACO ET25 con venturi e staffa Sile	156,00

Imbocco rettangolare 52x60 mm

			EURO
	CE007	LN250/2C-RA Ventola Ø97 Per caldaie 24KW Beretta, Riello, Ferroli, Fer	70,00
	CE009	LN250/2C-RO Ventola Ø108 Adattabile Vaillant VCW, VMW1	115,00

Imbocco quadrato 60x60 mm

			EURO
	CE006	LN250/2C-RA Ventola Ø97 Beretta, Riello, Ocean, Immergas, Chaffoteaux	120,00
	CE005	EBM/RLA108-RA Ventola Ø108 2 velocità Ocean FP	186,00

RO=Rotazione oraria - RA=Rotazione antioraria (lato ventola) - Adattabili, in certi casi recuperando alcuni dei componenti dal vecchio estrattore.

TAPPI E PRELIEVI FUMI

			EURO
	SP920	Kit prelievi filettati mm.20 Passaggio mm.8 Pz.10	42,00
	SP921	Kit prelievi filettati mm.45 Passaggio mm.8 Pz.10	45,00
	SP900	Kit prelievo filettato mm.35 Passaggio mm.11 PZ.1	39,00
	SP998	Tappi foro camino in silicone ad espansione - Pz.10	38,00



VETRINI PIREX PER CALDAIE

			EURO
	RF400	Spessore 3mm - Ø30mm	7,00
	RF401	Spessore 3mm - Ø40 mm	18,00
	RF402	Spessore 3mm - Ø50 mm	20,00

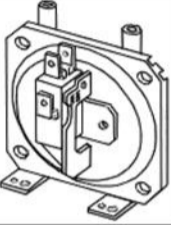
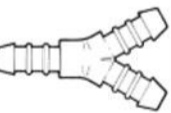
**PRESSOSTATI FUMI**

			EURO
	GP030	CLEVELAND NS2 Regolabile da 0,17 a 0,75 mbar Con staffa Honeywell	24,00
	GP001	Honeywell Reg.0,2/1mbar C6065A/1028.2 IN ESAURIMENTO	75,00
	GP010	HUBA - 0,47/0,35 mbar Immergas, Ferroli, Fondital	30,00
	GP016	HUBA - 0,65/0,51 mbar Riello, Beretta	30,00
	GP019	HUBA - 1,00/0,72 mbar Vaillant	30,00
	GP022	HUBA Control Regolabile da 0,2 a 30mbar	39,00
	SP110	Tubo silicone 5x8 mm Mt.1	5,00
	SP111	Tubo silicone 7x10 mm Mt.1	7,00
	SP115	Raccordo a Y per scarico condensa pressostato	2,00

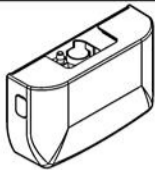
POMPE SCARICO CONDENSA ACIDA

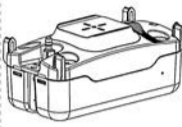
			EURO
	IT101	Aspen Kitchen Boiler Con contatto di blocco Montaggio sottocaldaia	221,00
	IT117	Sauermann SI 61 Per caldaie fino a 50KW Montaggio a parete o a terra	235,00
	IT103	Sauermann SI 83 ex SI82 Con contatto di blocco e protezione surriscaldamento	156,00

ASPEN Kitchen Boiler

L=182 x P=55 x H=115 mm
Alimentazione 230V
Serbatoio lt.0,5
Contatto allarme 3A max
Portata massima 12 l/h
Prevalenza max mt.10
Rumorosità max 21 dB

SAUERMANN Si 61

L=168 x P=90 x H=88 mm
Alimentazione 230V
Serbatoio lt. 0,37
Contatto allarme 4A max
Portata max 10 l/h
Prevalenza max mt.8
Rumorosità max 28dB

SAUERMANN Si 83 - Installazione parete e terra

L=287 x P=146 x H=129 mm
Alimentazione 230V
Potenza 115W
Contatto allarme 5A max
Serbatoio lt. 2,0
Portata max 700 l/h
Prevalenza max mt.5,7
Rumorosità max 45dB

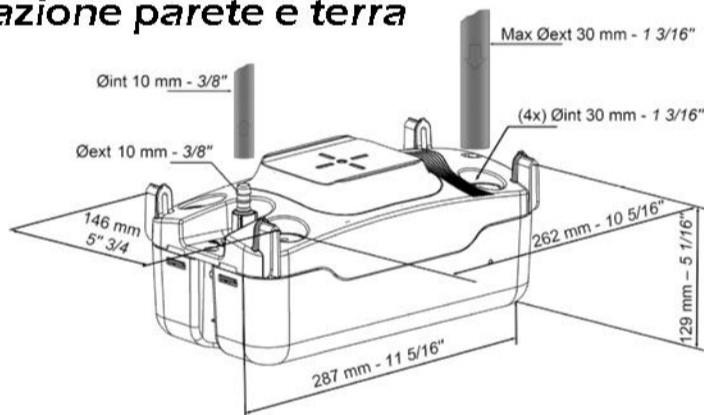





Accessori, ricambi e Sali per pompe e neutralizzatori

			EURO
	IT108	Cartuccia PH Safe Neutralizzatore di acidità per Sauermann SI83 e SI82	72,00
	IT105	Valvolina di ritegno di Ricambio per Si1805 - SI83	10,00
	IT106	Tubo scarico condensa PVC Ø10mm interno - Mt.1	3,00
	AC219	Tubo scarico condensa PVC Ø6mm interno - Mt.1	2,00

SAUERMANN PH-Safe

Cartuccia neutralizzante brevettata per installazione diretta nella pompa Si-83. Durata media 12mesi x una caldaia da 25kw
Può neutralizzare in 1 anno fino a lt.800 di condensa acida.
A Viraggio di colorazione.

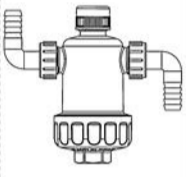
NEUTRALIZZATORI CONDENSA ACIDA

			EURO
	IT116	Aspen Mondeo Acid Neautralizer Small Attacchi a stringere Ø20 Per caldaie fino a 70kW	78,00
	IT118	Euroacque MININEUTRO Attacchi portagomma Ø20 Qmax 3 lt/h - L=230mm Per caldaie fino a 30kW	69,00
	IT107	RBM NT1 - Qmax 3 lt/h Attacchi portagomma Ø20 L=160mm H=136mm Per caldaie fino a 35kW	107,00
	IT114	Cillit KKN Colombo 11/20 Portata 56lh - Attacchi 3/4" M L410xH280xP225mm Per caldaie fino a 350kW	368,00
	IT091	Ferrari 350 Portata 35l/h - Attacchi 1" M L320xH240xP200mm Per caldaie fino a 350kW	379,00
	IT092	Ferrari 1500 Portata 150l/h - Attacchi 1" M L420xH240xP300mm Per caldaie fino a 3000kW	552,00

RBM NT1 - RICARICABILE:

Munito di sfiato atmosferico come previsto dalla norma UNI7129-05

Obbligatorio installarlo in posizione verticale.

Durata media alla massima potenza 1 anno.

Aspen Mondeo - USA E GETTA:

Attacchi a stringere per tubo da 20mm.

Portata Massima 2 lt/h.

Durata media 12 mesi

Euroacque MININEUTRO - RICARICABILE:

Comprende 2 attacchi da 20mm dritti, 1 a gomito e 2 supporti.



Durata media 9 – 12 mesi.

FERRARI 350: Durata 4450h a pieno carico

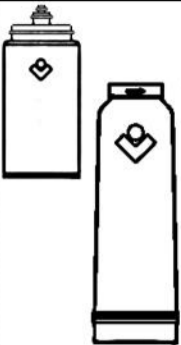

FERRARI 1500: Durata 1800h a pieno carico

COMPLETI DELLA PRIMA RICARICA

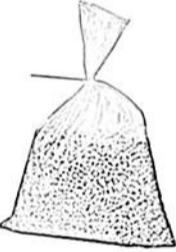
ACCESSORI, RICAMBI E SALI per pompe e neutralizzatori

			EURO
	IT111	Cartuccia ricambio per Cillit KKN S-N	184,00
	IT113	Cartuccia ricambio per Cillit KKN Medium e M-N	225,00
	IT119	Sali di ricambio per Euroacque MININEUTRO Sacchetto per una ricarica	25,00
	IT104	Sali di ricambio per RBM NT1 Sacchetto per una ricarica	26,00
	IT115	Sali ricambio per Cillit KKN Colombo e generici - Kg.5	64,00
	IT095	Sali ricambio granulato Confezione 10 kg	102,00
	IT096	Sali ricambio granulato Confezione 25 kg	315,00

CONTROLLO PH Acidità

			EURO
	SA722	Cartine tornasole PH per controllo acidità condensa Confezione Pz.50	18,00
	SA724	PHmetro Digitale HANNA Checker-Plus Misura l'acidità residua	63,00 NETTO

Hanna CHECKER PLUS:

- Display digitale
- Campo di misura: 0/14 pH
- Precisione: +/- 0,2 pH
- Elettrodo sostituibile
- Alimentazione 1 batteria CR2032 1,5V

TUBI ED ACCESSORI PER FUMISTICA IN PLASTICA PER CALDAIE A CONDENSAZIONE



Plastica PP Ø80 mm - Sistema sdoppiato

			EURO
	IT002	Prolunga MF - cm.25	9,00
	IT003	Prolunga MF - cm.50	9,00
	IT004	Prolunga MF - cm.100	14,00
	IT005	Prolunga MF - cm.200	26,00
	IT006	Curva 90° MF	8,00
	IT007	Curva 45° MF	8,00
	IT009	Riduzione a bicchiere 80M - 60F	22,00
	IT010	Riduzione a bicchiere 60M - 80F	22,00
	IT060	Riduzione a bicchiere 80M - 50F	23,00
	IT061	Riduzione a bicchiere 50M - 80F	20,00
	IT011	Raccordo a TEE - MMF	24,00
	IT012	Tappo scarico condensa per TEE	12,00
	IT043	Rosetta esterna in silicone Ø80mm	6,00
	IT040	Testina Pvc aspirazione aria	6,00
	IT041	Testina Inox per scarico fumi	14,00
	IT035	Guarnizione di ricambio a triplo labbro	6,00
	IT029	Collare Ø80mm con tassello	9,00
	IT051	Tubo flessibile giuntabile per controtubazioni. Ø80mm Prezzo al metro.	19,00

Plastica PP Ø60 mm



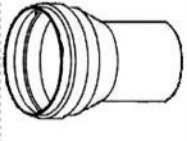

			EURO
	IT013	Prolunga MF - cm.25	12,00
	IT014	Prolunga MF - cm.50	10,00
	IT015	Prolunga MF - cm.100	15,00
	IT016	Curva 90° MF	10,00
	IT017	Curva 45° MF	10,00
	IT024	Testina antivento Inox	16,00
	IT025	Rosetta in silicone Ø60mm	5,00
	IT035	Guarnizione di ricambio a triplo labbro	6,00
	IT052	Tubo flessibile giuntabile per controtubazioni Ø60mm Prezzo al metro	18,00

Plastica PP Ø50 mm



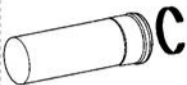
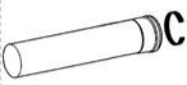
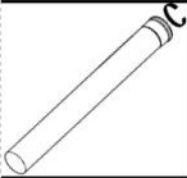

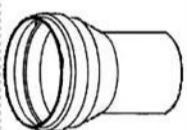
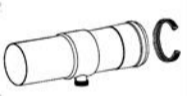
			EURO
	IT053	Tubo flessibile Ø50mm per controtubazioni Prezzo al metro	15,00
	IT055	Riduzione a bicchiere 50M - 60F	28,00
	IT054	Kit di adattamento giunzione rigido-flessibile Ø50mm, Ø60mm, Ø80mm	25,00

FUMISTICA PER CALDAIE TRADIZIONALI IN ESAURIMENTO

Alluminio smaltato Ø80 mm sistema sdoppiato

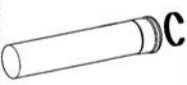
			EURO
	IT039	Prolunga MF - cm.25	11,00
	IT031	Prolunga MF - cm.50	15,00
	IT032	Prolunga MF - cm.100	25,00
	IT030	Curva 90° MF	18,00
	IT038	Curva 90° FF	24,00
	IT033	Curva 45° MF	18,00
	IT036	Tronchetto giunzione FF cm.20	23,00
	IT044	Riduzione a bicchiere 60/80 MF	21,00
	IT047	Tronchetto raccogli condensa orizzontale MF	67,00
	IT035	Guarnizione di ricambio a triplo labbro	6,00

Alluminio smaltato bianco Ø60 mm



			EURO
	IT019	Prolunga MF - cm.50	21,00
	IT023	Prolunga MF - cm.100	28,00
	IT020	Curva 90° MF	21,00
	IT021	Curva 90° FF	27,00
	IT022	Curva 45° MF	18,00
	IT028	Tronchetto giunzione FF	15,00

TUBI ED ACCESSORI PER FUMISTICA INOX PARETE SEMPLICE PER CANALI DA FUMO IN ESAURIMENTO

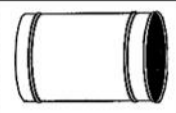
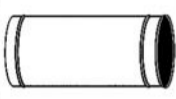
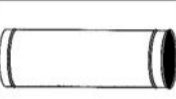
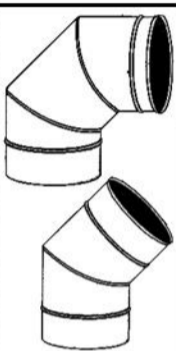
Ø120 mm - con guarnizione

			EURO
	IT120	Prolunga MF - cm.25	15,00
	IT121	Prolunga MF - cm.50	21,00
	IT122	Prolunga MF - cm.100	30,00
	IT123	Curva MF - 90°	22,00
	IT124	Curva MF - 45°	21,00
	IT126	Curva MF - 90° Regolabile da 0° a 90°	58,00

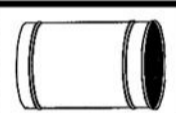
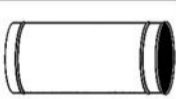
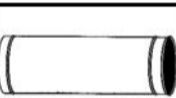
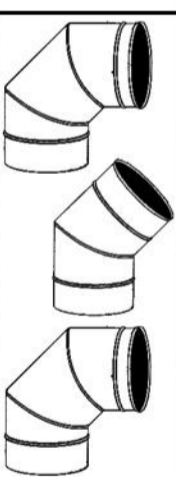
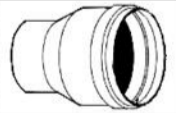

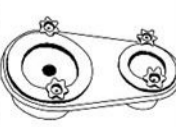

Ø130 mm - con guarnizione

			EURO
	IT130	Prolunga MF - cm.25	16,00
	IT131	Prolunga MF - cm.50	22,00
	IT132	Prolunga MF - cm.100	32,00
	IT133	Curva MF - 90°	26,00
	IT134	Curva MF - 45°	23,00
	IT135	Curva MF - 30°	23,00
	IT136	Curva MF - 90° Regolabile da 0° a 90°	59,00
	IT138	Riduzione Ø130F/120M mm	48,00
	IT137	Rosetta inox Ø130	11,00

Placca fumi Ispesl

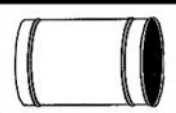
			EURO
	SC103	Placca controllo e prelievo fumi ISPEL (senza termometro)	58,00

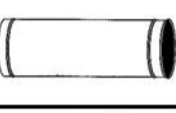
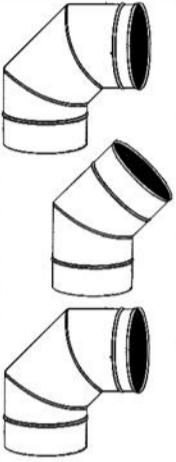
Ø140 mm - con guarnizione



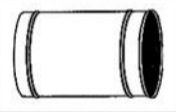
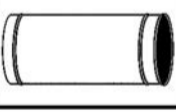
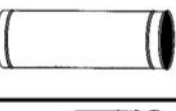
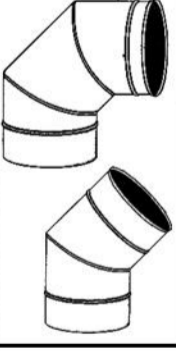
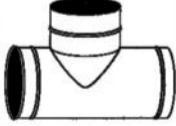

			EURO
	IT140	Prolunga MF - cm.25	17,00
	IT141	Prolunga MF - cm.50	23,00
	IT142	Prolunga MF - cm.100	34,00
	IT143	Curva MF - 90°	26,00
	IT144	Curva MF - 45°	23,00
	IT145	Curva MF - 30°	23,00
	IT146	Curva MF - 90° Regolabile da 0° a 90°	65,00
	IT148	Riduzione Ø140F/130M mm	52,00
	IT147	Rosetta inox Ø140	11,00

Ø150 mm - con guarnizione

			EURO
	IT150	Prolunga MF - cm.25	17,00
	IT151	Prolunga MF - cm.50	24,00
	IT152	Prolunga MF - cm.100	36,00
	IT153	Curva MF - 90°	28,00
	IT154	Curva MF - 45°	24,00
	IT156	Curva MF - 90° Regolabile da 0° a 90°	67,00
	IT159	Raccordo a TEE Specificare Ø130, 140, 150	80,00

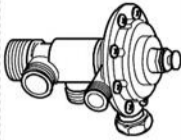
Tubazioni in acciaio inox Aisi316L , spessore 0,4 mm
EN 1856-2 Temperatura max con guarnizione 160°C
EN 1856-2 Temperatura max senza guarnizione 600°C
Prezzi comprensivi di guarnizione al silicone

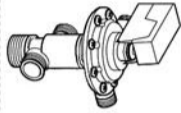
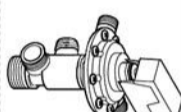
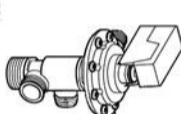
VALVOLE FLUSSOSTATICHE**GIANNONI**

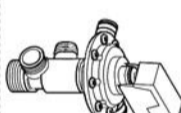
			EURO
	TP201	3vie Lamborghini Inova	178,00
	TP202	3vie con micro Arca, Idealclima Attacchi Tipo S	178,00
	TP203	3vie con micro Wolf, Arca, Sile Turbinox Attacchi Tipo O	178,00
	TP204	3vie con micro MTS, Ariston, Simat, Radi	178,00
	TP205	3vie con micro Lamborghini, Joannes	178,00
	CI002	3vie innesti rapidi e rubinetto carico Immergas Mini	178,00
	CH007	3vie innesti rapidi con micro Hermann Spazio tekno, Micra, Supermicra, Baltur Colibrì	212,00

MUT

			EURO
	TP001	VDP 3vie TIPO O Intercambiabile Giannoni Sime, ICI	155,00

Ricambi

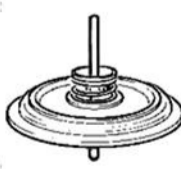
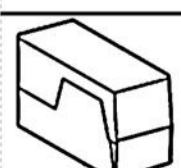
			EURO
	TP004	Membrana intercambiabile GIANNONI Completa di alberino e tenute	14,00
	TP014	Membrana ricambio per MUT VDP - Completa di alberino, piattello e molla	31,00
	TP013	Scatola microinterruttore doppio Ricambio per VDP	32,00

PRESSOSTATI PER CALDAIA

			EURO
	TP050	CEME - 1/8" M Pretarato 0,45 bar Pressostato sicurezza mancanza acqua - Contatti in scambio	19,00
	TP051	MATER - 1/4" M Pretarato 0,5bar Pressostato sicurezza mancanza acqua - Contatti in scambio	18,00
	TP010	Mut SFS1 - 1/4" M Pressostato differenziale a membrana - Micro singolo Disponibile anche 1/4" SAE per gruppi frigo	87,00

Ricambi

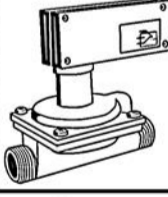
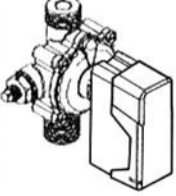
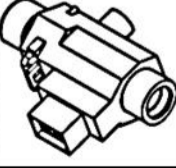
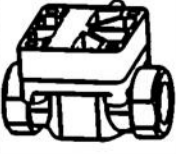

			EURO
	TP017	Scatola microinterruttore di ricambio per MUT SFS/SFP	43,00
	TP015	Kit revisione Mut SFS - SFP Membrana completa di gruppo magnetico	16,00

FLUSSOSTATI PER CALDAIA

			EURO
	TP009	Caleffi 315 NAV Flussostato a paletta 1/2" M	58,00
	TP008	Caleffi 315 NAV Flussostato a paletta 3/4" M	136,00
	TP011	Mut SFP1 - 1/2" M Flussostato a membrana Micro singolo	100,00
	TP005	Giannoni SF11 - 1/2" M Flussostato a membrana Micro doppio Hermann-Lamborghini	75,00
	TP022	Bitron Flussostato magnetico Attacchi 1/2" M verticale	24,00
	TP018	Flussostato 3/4" M Murali a condensazione Sile, Fondital	78,00

			EURO
	TP020	Honeywell C7195A/2001 1/2" M Sensore di portata (Flussometro)	34,00
	TP021	Caleffi 316 Flussometro 1/2" M Sensore portata in ottone	33,00
	TP023	Sensore portata ad angolo 1/2" M ottone (Flussometro) Fer-Feroli	48,00
	CV019	Flussostato rotativo Vaillant, Hermann, Saunier Duval	33,00
	TP024	Eltek 1/2" M Flussometro in PVC Ferrolì, Lamborghini, Unical	30,00

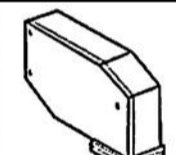
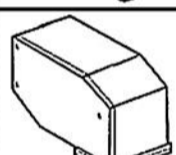
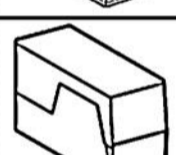
Ricambi

			EURO
	CM006	Microinterruttore singolo di ricambio per SF11	27,00
	TP012	Microinterruttore doppio di ricambio per SF11	20,00
	TP017	Scatola microinterruttore di ricambio per MUT SFS/SFP	43,00
	TP015	Kit revisione Mut SFS - SFP Membrana completa di gruppo magnetico	16,00
	GR710	Membrana ricambio per Giannoni SF11 - N°55	5,00
	TP006	Premistoppa per flussostato Dado 14mm + fresatura Fugas, Giannoni SF11	5,00

CIRCOLATORI ELETTRONICI PER CALDAIE**WILO - Interasse mm 130**

			EURO
	PC130	PARA RS15/6 NO PWM - Attacchi 1" Prevalenza max mt. 6	199,00
	PC131	PARA RS25/6 NO PWM - Attacchi 1"1/2 Prevalenza max mt. 6	199,00

Connettore a spina

			EURO
	PC506	Connettore Molex Cavo L=700mm	7,00

ONE PUMP - Interasse mm 130

			EURO
	PC710	GPA 7,5 III Pro Attacchi 1" Prevalenza max mt. 7,5	170,00
	PC711	GPA 7,5 III Pro Attacchi 1"1/2 Prevalenza max mt. 7,5	173,00

ASKOLL/TACO - Interasse mm 130

			EURO
	PC401	ES2 15/60-130 Attacchi 1" Prevalenza max mt. 6	287,00
	PC402	ES2 25/60-130 Attacchi 1"1/2 Prevalenza max mt. 6	287,00

DUCA - Solo motore

			EURO
	PC720	BPE-G Kit motore elettronico con cavi mt.8,5 Intercambiabile Grundfos	160,00
	PC721	BPE-W Kit motore elettronico con cavi mt.8,5 Intercambiabile Wilo	160,00

GRUNDFOS - Interasse mm 130

			EURO
	PC603	ALPHA 1L - 15/60-130 Con PWM - Attacchi 1" Prevalenza max mt. 6	CHIEDERE
	PC604	ALPHA 1L - 25/60-130 Con PWM - Attacchi 1"1/2 Prevalenza max mt. 6	CHIEDERE

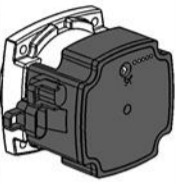

GRUNDFOS - Solo motore

	PC605	GRUNDFOS ALPHA 1 15/60 - Ricambio originale Per sostituire motori UPS	350,00
---	-------	--	--------

CIRCOLATORI TRADIZIONALI PER CALDAIE**ONE PUMP - Interasse mm 130**

			EURO
	PC120	GPD 15/6 - Attacchi 1" Motore intercambiabile GRUNDFOS UPS	140,00

DUCA - Solo motore

			EURO
	PC701	DUCA BPS-DW Kit motore con cavi - mt.5 Intercambiabile Wilo RS e Salmson NYL e DYL	110,00
	PC705	DUCA BPS-DG Kit motore con cavi - mt.7 Intercambiabile Grundfos UPS	115,00

Bocchettoni zincati

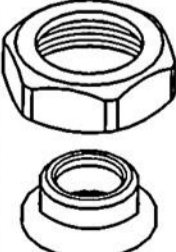
			EURO
	PC301	Coppia bocchettoni 1/2"F - 1"F	35,00
	PC302	Coppia bocchettoni 1"1/2F - 3/4"F	46,00
	PC303	Coppia bocchettoni 1"1/2F - 1"F	29,00

VALVOLE DEVIATRICI E ATTUATORI**HONEYWELL - Serie VC**

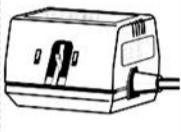
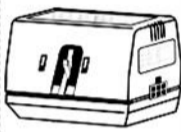
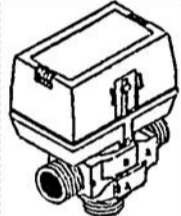
			EURO
	TZ101	VC6012 - 230V 50Hz Con morsettiera Molex	150,00
	TZ107	VC6612 - 230V/50Hz Micro e morsettiera Molex	109,00
	TZ109	VC4612/SPST - 230V/50Hz Micro e morsettiera Molex	267,00
	TZ103	VC6613 - 230V/50Hz Con micro e cavo cm.100	184,00
	TZ106	VC8610/SPST - 24V/50Hz Micro e morsettiera Molex Buderus, Tata (Ex 8010)	156,00
	TZ108	VC2010/SPDT - 24V/50Hz Con morsettiera Molex	129,00
	TZ035	Valvola VC6613MG6000 3vie 3/4" M - 220V Microinterruttore e cavo cm.100 Connessione SPDT a 3 fili	296,00

HONEYWELL - Serie VU

			EURO
	TZ031	VU4143H-1001 - 2vie 3/4" F Con microinterruttore	185,00
	TZ032	VU4143H-1019 - 2vie 1" F Con microinterruttore	216,00



Ricambi

			EURO
	TZ022	Motorino Synchron 230V per serie V4043/V4044	84,00
	TZ104	Otturatore flottante ricambio per VC 3vie - VCZZ6000	53,00
	TZ105	Otturatore flottante ricambio per VC 2vie VCZZ1000 Con chiave	87,00
	TZ050	Connettore 3 fili x VC6012 Con cavo cm.100	13,00
	TZ051	Connettore 6 fili x VC6612 Con cavo cm.100	55,00

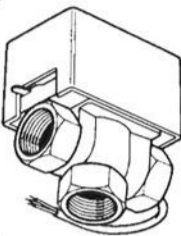
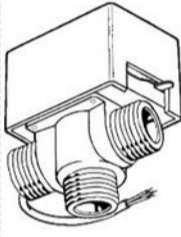
**MUT SF 3vie****Intercambiabile Honeywell V4044**

			EURO
	TZ010	SF15 - 1/2"F	139,00
	TZ011	SF20 - 3/4"F	141,00
	TZ012	SF25 - 1"F	147,00
	TZ015	SF20/E - 3/4"M	142,00
	TZ016	SF25/E - 1"M	147,00

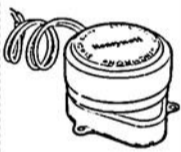
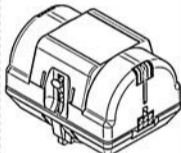
Ricambi

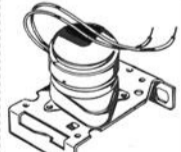
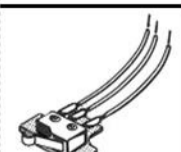
			EURO
	TZ022	Motorino Synchron 230V per serie SF	84,00
	TZ145	Attuatore MUT VMR 24V Intercambiabile Honeywell VC8010/8610	108,00
	TZ140	Otturatore flottante ricambio per valvola VMR 3vie	43,00
	TZ021	Motorino Synchron 230V con staffa MUT - 2 vie	84,00
	TZ023	Motorino Synchron 230V con staffa MUT - 3 vie	84,00
	TZ024	Motorino Synchron 24V-AC con staffa MUT - 3 vie Ecoflam	97,00
	TZ020	Kit microinterruttore ausiliario M1 per SF	16,00

ATTUATORI VALVOLE 3VIE per caldaia

			EURO
	TZ132	Honeywell VJ6012ZZ 230V Attuatore di ricambio Gruppo Imar	147,00
	TZ131	ELBI 230V Attuatore di ricambio	27,00
	TZ133	ELBI Motore/Attuatore Beretta, Riello modelli vari Immergas modelli vari	48,00

CARTUCCE PER VALVOLE 3 VIE E MOTORI

			EURO
	CR020	Cartuccia 3vie Beretta, Riello	46,00
	CM008	Cartuccia 3vie MTS, Chaffoteaux, Baxi, Sime, Ecoflam, Savio	20,00
	CO014	Cartuccia 3vie Baxi Luna 3, Luna 3 Confort, Luna 3 HT	40,00
	CC024	Motore e cartuccia per 3 vie Adattabile CMI Nectra	65,00
	CF006	Motore e cartuccia per 3vie Ferrolì, Joannes, Lamborghini	84,00
	CX001	Motore e cartuccia per 3 vie Adattabile VISSMANN	68,00
	CV011	Valvola 3 vie motorizzata Vaillant VMW1-2	120,00
	CV021	Valvola 3 vie motorizzata Vaillant Ecotec Plus 3-5	106,00
	CV020	Cartuccia 3 vie motorizzata Hermann, Saunier Duval, Vaillant	59,00
	CV017	Motore per valvola 3vie Vaillant VMW Ecotec, Turbo/Atmoblock	24,00

VASI DI ESPANSIONE**Circolari piatti - Ø325 mm**

		EURO	
	VE106	Vaso lt.6 - h118mm - 3/4"M	56,00
	VE107	Vaso lt.8 - h132mm - 3/4"M	57,00
	VE108	Vaso lt.10 - h150mm - 3/4"M	60,00
	VE109	Vaso lt.12 - h170mm - 3/4"M	63,00
	CO003	Vaso lt.6 - h100mm Attacco 14MA Adattabile Ocean 1° serie	56,00

Circolari piatti - Ø387 mm

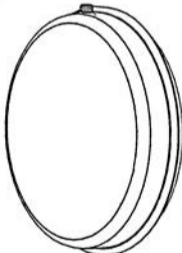
		EURO	
	VE101	Vaso lt.6 - h93mm - 3/4"M	60,00
	VE102	Vaso lt.8 - h110mm - 3/4"M	66,00
	VE103	Vaso lt.10 - h128mm - 3/4"M	69,00
	VE104	Vaso lt.12 - h142mm - 3/4"M	73,00
	VE105	Vaso lt.14 - h170mm - 3/4"M	77,00
	VE115	Vaso lt.8 - h90mm - 3/8"M Adattabile Immergas, Ferroli, Unical	66,00
	CO004	Vaso lt.8 - h110mm - 14MA Adattabile Baxi	66,00
	VE110	Vaso lt.10 - h120mm - 1/4"M Adatt. Beretta Idra, Riello 2000	69,00



Circolari a disegno speciale

			EURO
	VE118	Ø392 lt.8 - 1/2"M - h75mm Beretta Exclusive, Mynute, Super Exclusive, Residence Riello Nuova Benessere,	69,00
	VE114	Ø416 lt.8 - 1/4"M - h75mm Con staffa adattabile Beretta Idra Exclusive, Riello Benefit	84,00
	VE113	Vaso lt.10 - h128mm Attacco 3/4"M centrale Adattabile Unical GEA	69,00

 Rettangolari - Precarica 1bar

			EURO
	VE201	Cimm lt.6 - 3/4"M 512 x 196 x 100 mm	65,00
	VE205	Cimm lt.8 - 3/4"M 512 x 196 x 113 mm	67,00
	VE206	Cimm lt.10 - 3/4"M 512 x 196 x 128 mm	72,00
	VE207	Cimm lt.12 - 3/4"M 512 x 196 x 146 mm	75,00
	VE202	Zilmet lt.7,5 - 3/4"M 490 x 200 x 120 mm	116,00
	VE203	Zilmet lt.10 - 3/4"M 490 x 200 x 150 mm	130,00
	VE204	Zilmet lt.12 - 3/4"M 490 x 200 x 175 mm	133,00
	VE116	Cimm lt.8 - 3/8"M 512 x 196 x 113 mm Adattabile Immergas, Ferroli	67,00
	VE119	Zilio lt.6 - 3/8"M 490 x 200 x 65 mm	66,00

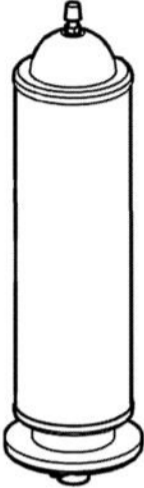
Cilindrici Idrici

			EURO
	VE006	Cimm lt.2 1/2" M - Ø120x240mm Adattabile Beretta, Riello, Immergas Zeus, Hercules	41,00
	VE001	Cimm lt.5 - 3/4" M Ø170x275mm	48,00
	VE010	CIMM Style lt.2 - 1/2" M Ø80 x 440 mm	83,00
	VE011	CIMM Style lt.3 - 1/2" M Ø90 x 560 mm	89,00
	VE012	CIMM Style lt.4 - 1/2" M Ø90 x 655 mm	102,00
	VE021	ZILMET 564 lt.3 - 1/2" M L=450mm Sezione ovale	141,00
	VE022	ZILMET 564 lt.4 - 1/2" M L=600mm Sezione ovale	182,00

Raccordi adattatori

			EURO
	RN049	Manicotto 3/8" M x 3/4" F	20,00
	RN050	Manicotto 1/2" M x 3/4" F	18,00

MINICOMPRESSORE GONFIAVASI

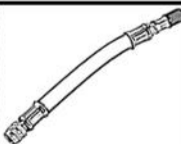

			EURO
	SP503	POWERPLUS POWX1700	80,00
	SP507	Batteria di ricambio per POWX1700	38,00
	SP504	Prolunga flessibile cm.20 Per carico vasi	13,00

POWX1700 - Minicompressore gonfiavasi completo di batteria, manometro e tubo, fornito in valigetta, tempo carica circa 1 h, peso (batteria inclusa) 1,1 Kg, pressione massima 8 bar, batteria al Li-Ion 18V - 1500mAh, portata 35 l/min.

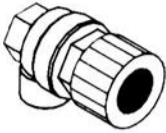



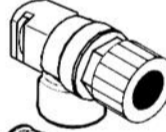
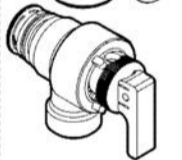
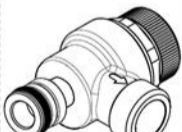

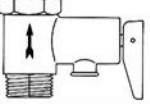

VALVOLE SICUREZZA KRAMER

			EURO
	VE504	3 bar - 1/2"F	9,00
	VE506	6 bar - 1/2"F	9,00
	VE509	7 bar - 1/2"F	9,00
	VE505	3 bar - 1/2"M	9,00
	VE507	6 bar - 1/2"M	9,00
	VE525	7 bar - 1/2"M	9,00
 	VE508	3 bar - 1/2"M Pres a portamanometro 1/4"F	11,00
	VE503	3 bar - 1/2"F Pres a portamanometro 1/4"F	11,00
	VE530	Testina di ricambio Kramer 3 bar	8,00
	VE531	Testina di ricambio Kramer 8 bar	9,00

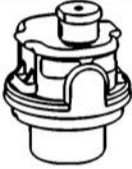
Attacchi speciali

			EURO
	VE524	3 bar - Attacco O.R. generico Adattabile Immergas, Baxi	10,00
	CR008	3 bar Attacco O.R. Beretta/Riello	11,00
 	CV013	3 bar innesto rapido femmina per Vaillant VM	18,00
	CV022	3 bar innesto rapido per Vaillant VM, VMW - HSD Micra3/4, Thema3/4, Themafast	15,00
	CM009	3bar in composito Innesto O.R. - Uscita 3/8"M MTS, CMI, Ecoflam	14,00
	VE532	3bar in composito Innesto O.R. - Uscita 1/2"M Baxi, Ferroli, HSD	10,00
	CR011	Valvola 3 bar in composito Innesto O.R. - Uscita 1/2"M Beretta/Riello	10,00
	CO015	Valvola 3 bar in composito Innesto O.R. - Uscita rapido Baxi Eco5-Evolution prime	27,00
	RS011	Valvola di ritegno 1/2" - 8bar Con leva di scarico-scaldabagno	23,00

VALVOLE SFIATO ARIA

			EURO
	VE501	Caleffi Minical 5020 - 3/8" Prezzi netti per quantita'	15,00
	VE490	Caleffi Minical 5020 - 1/2" Prezzi netti per quantita'	15,00
	VE502	Pintossi 507 - 3/8" Prezzi netti per quantita'	13,00
	VE500	Pintossi 507 - 1/2" Prezzi netti per quantita'	13,00
	VE523	Caleffi Robocal 3/8" Prezzi netti per quantita'	12,00
	VE480	Caleffi in plastica a innesto rapido per Wilo e Grundfos Prezzi netti per quantita'	10,00
	VE481	Caleffi in plastica a innesto rapido per Wilo e Grundfos Ingombro ridotto Per circolatori elettronici	15,00
	VE482	Caleffi in plastica a innesto rapido con alette di fissaggio Prezzi netti per quantita'	15,00
	CO013	Caleffi - Testina Jolly filettata Adattabile Baxi, Saunier Duval	13,00
	VE571	Per pannelli solari 3/8" Tmax 150°C	18,00
	VE572	Per pannelli solari 1/2" Tmax 150°C	19,00
	VE560	Valvolina sfiato radiatori 1/4"	7,00
	VE561	Valvolina sfiato radiatori 3/8"	8,00

RUBINETTI CARICAMENTO CALDAIA

			EURO
	CR005	Adattabile Beretta, Riello, MTS Ariston	16,00
	VE521	37 mm - Adattabile Hermann, Unical, Fondital Vela/Panarea, Radiant	10,00
	CO012	Adattabile Baxi serie Luna, Eco	25,00
	CO006	Manopola estraibile Ariston, Baxi, Ecoflam	9,00
	VE528	60 mm - Adattabile Immergas Nuova Avio, Fondital Tahiti, Nova Florida Pictor	11,00
	VE529	75 mm - Adattabile Hermann, Lamborghini	11,00
	CI006	104 mm - Adattabile Immergas, Hermann	11,00
	CI013	Adattabile Immergas Eolo, Nike	17,00
	CV003	Adattabile Vaillant Ecoblock, VMW Plus 2-3-4, e Turboplus 2-3-4	19,00
	CF013	1/2"M-3/4"M - Adattabile Ferrolti	58,00

RUBINETTI SCARICO CALDAIA

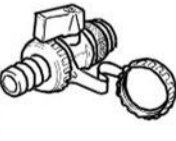
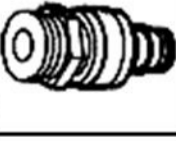
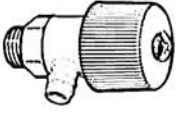
			EURO
	VE520	Scarico caldaia 1/2"M con tappo	14,00
	VE540	Scarico bollitore 1/2"M con tappo	8,00
	VE541	Orientabile per caldaie murali 1/4"M	8,00

**GRUPPI DI CARICO**

			EURO
	CF010	Feroli Domina, Igloo, Domitop DGT	33,00
	CF011	Feroli Domicompact, Ferella Zip	33,00
	CF014	Feroli Domitop, Ferella Gold	26,00
	CH003	CEME - Elettrovalvola di Caricamento automatico 1/4\"M x 1/2\"M Hermann serie Spazio, Unical Ipsen, Entrofuori, Enter	40,00

RUBINETTI MINIBALL

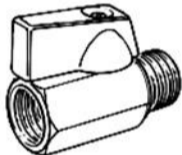
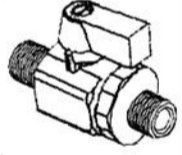
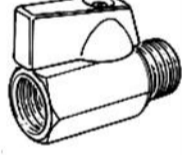
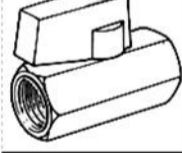
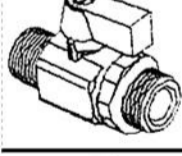
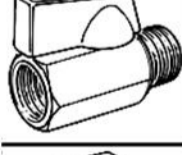
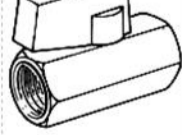
			EURO
	NF400	Rubinetto a sfera 1/4\" MF	9,00
	NF403	Rubinetto a sfera 1/4\" MM	9,00
	NF401	Rubinetto a sfera 3/8\" MF	9,00
	NF404	Rubinetto a sfera 3/8\" FF	9,00
	NF405	Rubinetto a sfera 3/8\" MM	9,00
	NF402	Rubinetto a sfera 1/2\" MF	10,00
	NF406	Rubinetto a sfera 1/2\" FF	10,00

SCAMBIATORI A PIASTRE SALDOBRASATE

		EURO
	CR012 Attacchi O.R. con labbro 14 P Beretta, Riello, Rhoss, Baltur, Arca, Buderus	65,00
	CR019 Attacchi O.R. con labbro 16 P Beretta, Riello	64,00
	CO007 Attacchi O.R. 14 piastre Ocean Luna, C.M.I. Nectra Saunier Duval Isofast	60,00
	CO009 Attacchi O.R. 14 piastre Baxi Luna/Eco	60,00
	CO008 Attacchi O.R. 16 piastre Baxi Luna/Eco	69,00
	CH005 Attacchi O.R. 14 piastre Saunier Duval Thema Fast, Thema Classic	60,00
	CM002 Attacchi O.R. 14P Simat,Rhoss, Ariston,Ecoflam,Radi,Fondital, Baxi, Farel, Tata Lady e Dream	61,00
	CM013 Attacchi O.R. 16 piastre Simat, Ariston, Radi Modelli a pag.14	61,00
	CM001 Attacchi O.R. 14 piastre Chaffoteaux, Ariston Modelli a pag.14	46,00
	CN002 Attacchi O.R. 14 piastre Chaffoteaux, Ferroli, Fondital, Lamborghini (Ariston Modelli a pag.14)	58,00
	CF005 Attacchi filettati 1/2-3/4" M 14 P adattabile Hermann Spazio plus, Ferroli	60,00
	CH011 Attacchi filettati 14 piastre Sime Open, Format BF, Planet, Hermann Micra	83,00
	CI007 Attacchi filettati 13 piastre Immergas Nike, Eolo Mini	84,00
	CI015 Attacchi filettati 14 piastre Immergas Eolo Mini KW, Unical, Radiant, Fontecal	50,00
	CS101 Attacchi O.R. 14 piastre Sime Format, Format Zip, Murelle	191,00

			EURO
	CV002	Kit completo di raccordi per sostituzione scambiatore originale in composito 14 Piastre - Vaillant VCW	100,00
	CV009	Attacchi filettati 14 Piastre Vaillant VCW Senza raccordi	66,00
	CV010	Attacchi a 3 innesti rapidi 14 Piastre Corto L=190mm per Vaillant VMW3-5 - Pro	60,00
	CV016	Attacchi a 3 innesti rapidi 20 Piastre Corto L=190mm per Vaillant VMW3-5 - Pro	84,00
	CV012	Attacchi a 3 innesti rapidi 14 piastre - Lungo per Vaillant VMW3-5	75,00
	CV014	Attacchi O.R. con alette 14 P Vaillant Ecoblok Pro, Turboblock Plus	66,00
	CV015	Attacchi O.R. con alette 20 P Vaillant Ecoblok Pro, Plus	82,00
	CB010	Attacchi O.R. 18 piastre 3 alette Bosch Cerapur	66,00
	CX003	Attacchi O.R. 12 piastre con alette Viessman Vitopend	57,00
	CP005	28 Piastre 40 KW -> ΔT30°C Per separazione impianti Attacchi filettati 3/4\"M	102,00
	CP006	40 Piastre 60 KW -> ΔT30°C Per separazione impianti Attacchi filettati 3/4\"M	129,00

Gli scambiatori di grossa portata CP005 e CP006 sono ideali per separare l'impianto dalla caldaia, in presenza di termocucine e termocaminetti.

MISURE INTERASSI DEI TIRANTI PER MODELLI CON ATTACCHI A O.R.





CH005	172 mm	CO007	178 mm
CI015	153 mm	CO008	157 mm
CM001	142 mm	CO009	157 mm
CM002	165 mm	CR012	147 mm
CN002	147 mm	CR019	147 mm

TERMOMETRI A CAPILLARE

			EURO
	TX001	Quadrante Ø42mm - Foro Ø37mm, capillare mm.1500 Disponibile bianco o nero	11,00
	TX002	Quadrante Ø56mm - Foro Ø52mm, capillare mm.1500 Colore nero	11,00
	TX004	Quadrante 42x42mm Foro Ø37mm Colore nero Beretta Idra	11,00
	TX003	Quadrante rettangolare 65x30mm Foro 58x25mm Colore nero - Unical	11,00
	TX007	Quadrante rettangolare 70x14mm - Foro 62x11mm Colore nero - Riello	11,00
	CV006	Quadrante 48x48mm Foro quadro 45x45mm Colore nero - Vaillant, Ecoflam	46,00

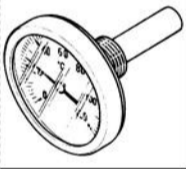
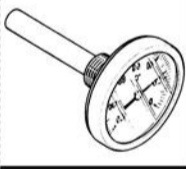
TERMOMETRI E PIROMETRI

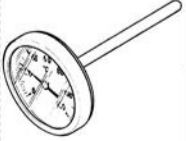
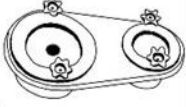
			EURO
	TX005	A immersione 0/120°C Ø63mm gambo 1/2" x 50mm INAIL	9,00
	TX008	A immersione 0/120°C Ø80mm gambo 1/2" x 100mm INAIL	12,00
	TX009	A immersione 0/120°C Ø80mm Gambo 1/2" x 50mm Attacco radiale INAIL	66,00
	TX006	A bracciale cassa inox 0/120°C Ø63mm Completo di molla	8,00
	SC100	Pirometro fumi cassa inox 0/500°C Ø63mm gambo mm150	12,00
	SC010	Pirometro fumi cassa inox 0/500°C Ø63mm gambo mm200	13,00
	SC103	Placca controllo e prelievo fumi INAIL - IN ESAURIMENTO	58,00

IDROMETRI A CAPILLARE E MANOMETRI





			EURO
	TI001	Quadrante Ø42 mm Foro Ø37 mm - 1/4" M Colore nero	14,00
	TI002	Quadrante Ø56 mm Foro Ø52 mm, 1/4" M Colore nero	14,00
	TI004	Quadrante 42x42mm Foro Ø37 mm, 1/4" M Colore nero - Beretta Idra	14,00
	VE603	Manometro 0/4 bar Ø50mm Attacco radiale 1/4" M	14,00
	VE604	Manometro 0/10bar Ø50mm Attacco radiale 1/4" M	14,00
	VE605	Manometro 0/6 bar Ø50mm Attacco posteriore 1/4" M	17,00
	VE606	Manometro 0/4 bar Ø40mm Attacco posteriore 1/8" M Radiant, FBR, Hermann	10,00

TERMOIDROMETRI A CAPILLARE

			EURO
	TI003	Quadrante Ø56mm Foro Ø52mm - Att. 1/4" M Colore nero	21,00
	TI005	Quadrante Ø56mm Foro Ø52mm - Att. 14MA Disponibile Bianco o nero	21,00
	CI008	Quadrante Ø44mm Foro Ø40mm - Att. 1/4" M Colore bianco Immergas, Ferroli	21,00
	TI006	Quadrante Ø46mm Foro Ø42mm - Att. 1/4" M Colore bianco Hermann, Riello Domus	21,00
	TI010	Raccordo fresato adattatore per idrometri Passo gas 1/4" o 14MA	13,00

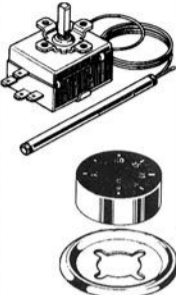
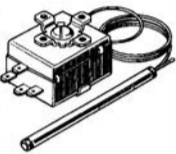
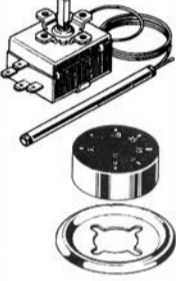
TERMOSTATI A CAPILLARE

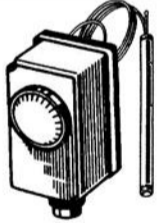
Regolazione

			EURO
	TT106	TR2 - Regolazione 0/40°C 3 contatti - Capillare mm.1000 Con manopola e ghiera	40,00
	TT105	TR2 - Regolazione 0/65°C 3 contatti - Capillare mm.1500 Rivest.PVC - Manopola e ghiera	32,00
	TT103	TR2 - Regolazione 0/90°C INAIL 3 contatti - Capillare mm.1500 Rivest.PVC - Manopola e ghiera	37,00
	TT101	TR2 - Regolabile 30/90°C 3 contatti - Capillare mm.1500 Regolazione cacciavite	38,00
	TT132	Regolabile 30/110°C 3 contatti - Capillare mm.1500 Con manopola e ghiera	32,00
	TT130	Regolabile 30/160°C 3 contatti - Capillare mm.1500 Con manopola e ghiera	32,00
	TT133	Regol.50/200°C - bulbo Ø3mm 3 contatti - Cap.inox mm.1500 Con manopola e ghiera	32,00
	TT131	Regol.50/350°C - bulbo Ø3mm 2 contatti NC Cap.inox mm.1500 Manopola e ghiera	46,00
	TT110	IMIT regolazione 0/90°C Inscatolato Capillare mm.1000	84,00
	TT010	Pozzetto ricambio 1/2" Varie lunghezze Disponibile per 1 o 3 sonde	22,00



Sicurezza

			EURO
	TT104	LS1 - Riarmo manuale 100°C 3 contatti INAIL Cap.mm.1500 Rivestito PVC	38,00

BITERMOSTATI per generatori d'aria calda

			EURO
	TB002	IMIT TTCA/870 - L280mm Regolazione ventilatore esterna 0-60°C	143,00
	TB104	HONEYWELL L4064B2210 L=290mm - Comando ventilatore Scala in gradi Fahrenheit F° Sostituisce vecchi modelli B1725 e N1074	242,00

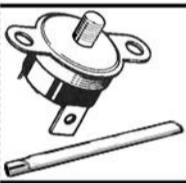
TERMOSTATI A MICROCONTATTO

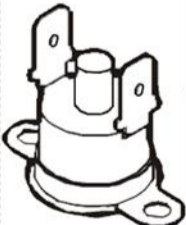
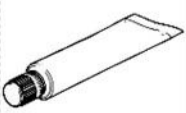
			EURO
	TK003	T3 - Antigelo NA Inserimento + 3°C disinserimento + 16°C	7,00
	TK015	Kit blister 42°C NA cavi + staffa per il fissaggio tra le alette della batteria alettata dei convettori	13,00
	TK010	T40 - 42°C NA - Ventilconvettori Con molla fissaggio al tubo	7,00
	TK009	T60 - 60°C NA - Ventilconvettori Con molla fissaggio al tubo	7,00
	TK011	T70 - 70°C NC	7,00
	TK014	T80 - 80°C NC	7,00
	TK012	T90 - 90°C NC	7,00
	GR441	T105 - 105°C NC Contatti dorati	8,00
	TK013	T110 - 110°C NC Contatti dorati	7,00
	TK016	T120 - 120°C NC Contatti dorati	7,00
	TK035	Termostato fumi 75°C NC Contatti dorati	7,00
	TK036	Termostato limite Riarmo manuale 140°C NC Per ventilconvettori	17,00
	TK101	Pasta per contatti - gr.50	7,00











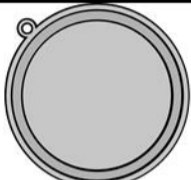

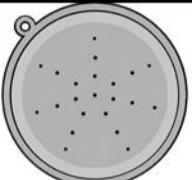

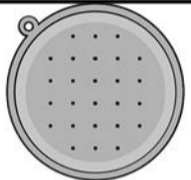

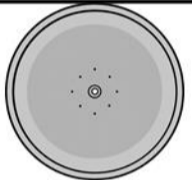

MEMBRANE PER CALDAIE E SCALDABAGNI

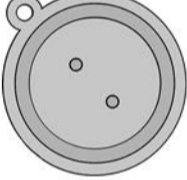
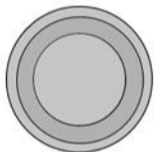
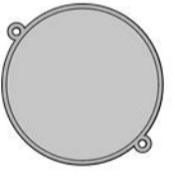
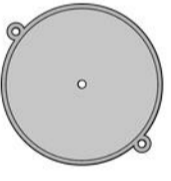
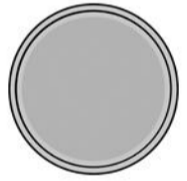
EURO

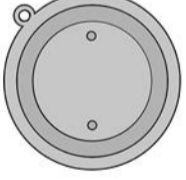
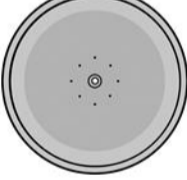
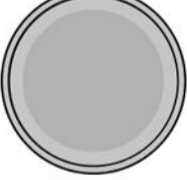
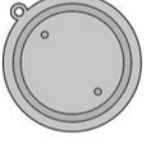
GR710 Membrana per caldaie e
scaldabagni

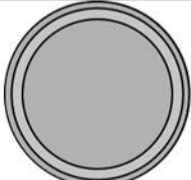
5,00

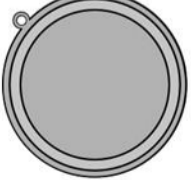
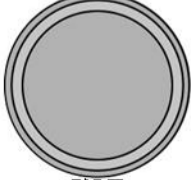
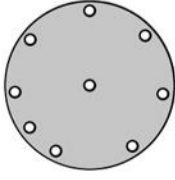
Per richiedere le membrane verificare misure, forma, aspetto e referenze, indicare il numero identificativo riportato in ogni riquadro in alto a sinistra. Disponibili anche altri modelli.

3  Ø88 BERETTA Paros	55  Ø44 BERETTA Paros, MTS, HERMANN, BAXI, LAMBORGHINI	76  Ø90 BERETTA Idra, RIELLO 2000 Sanit.	67  Ø44 BERETTA Idra, RIELLO 2000 Riscald.
75  Ø78 - BERETTA Meteo, Exclusive, Mynute	75A  Ø47 - BERETTA Idra Exclusive, Meteo, Mynute	71  Ø78 RIELLO Benefit, Residence	12  Ø65, h=15 Scaldabagni BERETTA, RIELLO, SYLBER
70  Ø72 - Foro Ø11 IMMERGAS Super Nike, Super Eolo	72  Ø63 - IMMERGAS Nike, Eolo	82  Ø80 - IMMERGAS Major, Superior	46  Ø63 - UNICAL DUA C
15  Ø70 - Scaldabagno VAILLANT	66  Ø70 - VAILLANT VCW Lato sanitario	84  Ø75 - VAILLANT VCW Lato riscaldamento	85  Ø57 VAILLANT VMW
69  Ø76 - OCEAN Solaria, 2002	83  Ø80 - OCEAN/BAXI Luna, Eco	86  Ø80 - ECOFLAM, MTS, RHOSS	60  Ø63 SAUNIER DUVAL
25  Ø55 Chaffoteaux et Maury	43  Ø85 Chaffoteaux et Maury G15-20-30, TIG	51  Ø56 Chaffoteaux et Maury Bayard, Celtic, GM	58  Ø54 Chaffoteaux et Maury Vecchi modelli
59  Ø87 Chaffoteaux et Maury GS, GM, Celtic	65  Ø87 Chaffoteaux et Maury Multi, M20, Cortina, RS	32  Ø75 - LEBLANC	7  Ø51, h=12 JUNKERS

PRODOTTI PULIZIA CALDAIE A CONDENSAZIONE

Kit HYSPRAY - LATO FUMI

			EURO
	SA360	Kit pulizia scambiatori per caldaie a condensazione in alluminio e acciaio	148,00
	SA361	Liquido detergente alcalino di ricambio Lt.2 - Mechim	16,00
	SA365	Pompa erogatrice ricambio	66,00

Il Kit comprende 2 lt di detergente liquido alcalino, 1 pompa a pressione (necessaria per l'utilizzo), 1 spazzola, 1 set lame pulizia lamelle, 1 tubo di scarico delle morchie. Adatto sia per scambiatori in alluminio/silicio che in acciaio. Il Set lame può essere richiesto come ricambio.

Kit CHEM - LATO FUMI

			EURO
	SA362	TA88 - DECACOMB AL - lt.1 Specifico per alluminio/silicio	50,00
	SA363	TA90 - DECACOMB - lt.1 Specifico per acciaio inox	50,00

TA88 / TA90 - Rimuove gli ossidi e i residui di combustione dalle superfici degli scambiatori di tutti i tipi di caldaie da riscaldamento penetrando in profondità. Decompone i depositi trasformandoli in composti volatili e lavabili dall'acqua. Contiene degli speciali inibitori di corrosione che tengono sotto controllo l'attacco acido e rallenta il fenomeno della corrosione delle superfici metalliche.

Contribuisce anche a ripristinare il corretto scambio termico.

Risciacquare abbondantemente con acqua.

MODALITA' D'USO

A spruzzo: Rimuovere i residui più grossolani, applicare con l'erogatore, nebulizzare e lasciare agire per almeno 10 minuti.

Per immersione (solo con TA88):

Diluire in acqua al 30% e lasciare agire per max 15 minuti.

FORIDRA - Pulitore LATO ACQUA

			EURO
	SA465	Idraclean caldaia Lt.5 Disincrostante non corrosivo per caldaie murali	83,00
		CLEAN TANK - Contenitore pressurizzabile per lavaggio con Idraclean - SU ORDINAZIONE	

Rimuove le incrostazioni da ossidi metallici dai circuiti primari delle caldaie, anche a condensazione. Usare con CLEAN TANK, diluito in acqua dal 30 al 50 % e fatto girare col circolatore della caldaia da 4 a 8 ore, poi risciacquare.

Compatibile con tutti i metalli (anche alluminio) e plastiche.

PRODOTTI DETERGENTI

			EURO
	SA165	PINECO Ecofiltri - Lt.1 Specifico per filtri	30,00
	AC240	DK-SAN RTU - Lt.1 - PMC Detergente disinfettante pronto all'uso (diluito 2,5%)	18,00
	AC241	DK-SAN - Lt.5 - PMC Concentrato da diluire 2,5/5%	108,00

Detergenti liquidi per batterie alettate e filtri. Possono essere anche utilizzati nella pulizia di locali caldaia, pezzi meccanici ed altro.

PRODOTTI CONDIZIONANTI PER IMPIANTI

			EURO
	SA421	CHEM TA100 POCKET Condizionante per impianti Termici - Busta da g.60	44,00
	SA440	CHEM TA65 ALLARM MAG It.1 Decapante pulitore protettivo	39,00

TA100:

Polvere a triplice azione, protettiva, anticorrosiva, deossigenante e algicida. 1 busta per impianti fino a lt.200

TA65:







Liquido inibitore protettivo, solleva i depositi nell'impianto e li trasporta fino al filtro defangatore magnetico facilitando la raccolta di magnetite.

STABILIZZANO IL PH Studiati per tutti i tipi di metalli e materiali plastici. Permane e previene la corrosione, le incrostazioni e la formazione di alghe.

SCOVOLI PER PULIZIA CALDAIE

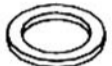
			EURO
	SA040	Kit scovoli per murali Conf.Pz.10 misure assortite	58,00
	SA019	Scovolini pulizia Ø30mm L=cm.100 - Ottone	6,00
	SA020	Scovolini pulizia Ø35mm L=cm.100 - Nylon	7,00

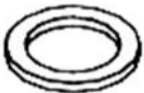
GUARNIZIONI ESENTI AMIANTO

			EURO
	GG006	Guarnizione 1/8" - Pz.10 Confezione Pz.100	2,00 18,00
	GG005	Guarnizione 1/4" - Pz.10 Confezione Pz.100	2,00 18,00
	GG004	Guarnizione 3/8" - Pz.10 Confezione Pz.100	2,00 18,00
	GG001	Guarnizione 1/2" - Pz.10 Confezione Pz.100	2,00 18,00
	GG002	Guarnizione 3/4" - Pz.10 Confezione Pz.100	3,00 25,00
	GG003	Guarnizione 1" - Pz.10 Confezione Pz.100	4,00 32,00
	GG010	In gomma per bocchettoni 1" Pz.10 - Spessore mm.3	4,00
	GG011	In gomma per bocchettoni 1"1/2 Pz.10 - Spessore mm.3	6,00

Per confezioni da Pz.1000 prezzi speciali

SIGILLANTI in nastro

			EURO
	RF205	TEFLON DVGW uso gas Bobina PTFE 1/2"	2,00
	RF204	TEFLON DVGW uso gas Bobine PTFE 1/2" - Conf.Pz.10	12,00
	RF208	TEFLON ROSA -Tmax 140° Bobina PTFE 1/2" Per alta temperatura, adatto per impianti solari e vapore	8,00
	RF203	TEFLON Giallo - PTFE 3/4" A norma DIN-DVGW	10,00
	RF220	LOCTITE 55 - mt.150 Sigillafiletto a filo di teflon omologato DVGW	29,00
	RF207	NASTRO alluminio adesivo h.50 mm x mt.50	22,00
	RF209	FACOT - Silicon Tape Sigillante ad effetto dinamico Adatto per alte temperature	10,00

SILICON SEALING TAPE E' un nastro in fibra sintetica impregnato con un particolare mastice non indurente. Sigilla raccordi filettati di qualunque diametro e materiale, adatto per gas (vapore, GPL, metano), acqua potabile, acidi, riscaldamento e pannelli solari. Dinamico, si adatta a tutti i filetti ed a qualsiasi materiale ed è riposizionabile anche a distanza di anni.





PRODOTTI SIGILLANTI

			EURO
	RF200	LOXEAL 58-11 - Sigillafiletti anaerobico 100 ml DIN-DVGW	42,00
	RF212	LOXEAL 58-31 - Guarnizione liquida 75 ml Temperatura – 55 / + 150°C	39,00
	RF210	LOXEAL 11 - Attivatore spray Acceleratore di indurimento dei sigilla filetti - 200 ml	29,00
	SA160	SALDASYSTEM - Stucco bicomponente riparatutto-rapido. Anche sott'acqua. Indurisce in pochi minuti.	18,00

LOXEAL 58-11 Utilizzato in sostituzione di canapa o teflon, è omologato per gas, GPL ed acqua potabile, a norme DIN/DVGW. Indurisce in 15/30 minuti. (5 minuti abbinato a LOXEAL11)

LOXEAL 58-31 Sigilla le superfici piane, sostituisce le guarnizioni preformate con una elastica e flessibile, recupera fino a 5 decimi di mm. Indurisce in 30 minuti.

DISSODIANTI, LUBRIFICANTI ed altri prodotti

			EURO
	SP104	ECOFUGHE - ml.400 Rilevatore fughe gas spray	9,00
	SP113	TOP REVEL GAS - ml.400 Rilevatore fughe gas spray NON INFIAMMABILE	22,00
	SA352	SILIC SPRAY - ml.400 Lubrificante non oleoso al silicone	16,00
	SA355	WD40 - ml.400 - Disossidante lubrificante professionale	19,00
	SA356	CHEM SP17 - ml.400 Solvente per elettronica Elimina lo sporco senza lasciare residui né aggredire i materiali di supporto	30,00
	SA162	ECONET - Erogatore ml.750 Spray sgrassante - Adatto per mantelli caldaie e pavimenti delle centrali termiche	18,00
	GR564	Grasso al silicone MS4 Tubetto gr.25	7,00